

# Firearms Training Manual

## STUDENT HANDBOOK AND STUDY GUIDE



Prepared by

**THE FLORIDA DEPARTMENT OF AGRICULTURE AND CONSUMER SERVICES**

**Division of Licensing**

FDACS P-02079  
Eff. 09/2016  
Rule No. 5N-1.132, F.A.C



**Florida Department of Agriculture and Consumer Services**

## **Introduction to the Firearms Training Manual STUDENT HANDBOOK AND STUDY GUIDE**

---

### **ABOUT THE FIREARMS TRAINING MANUAL (FTM)**

Chapter 493, Florida Statutes, requires an applicant for a Class “G” Statewide Firearm License to satisfy minimum training criteria for firearms established by rule of the department, which includes but is not limited to, 28 hours of range and classroom training taught and administered by a Class “K” instructor. Once licensed, each Class “G” licensee must also submit proof annually that he or she has received a minimum of 4 hours of firearms requalification training taught by a Class “K” instructor during each year of the license period. Additionally, a Class “G” licensee whose job duties require him or her to carry a firearm of a type and caliber different from or in addition to the firearm upon which he or she is qualified, must take a 4-hour training class specific to that firearm’s type and caliber. This Firearms Training Manual (FTM) establishes the minimum training criteria for each course.

The FTM consists of two separate but related parts: the Student Handbook and Study Guide, FDACS P-02079, eff. 09/16 (Student Handbook), and the Instructor’s Guide, FDACS P- 02078, eff. 06/16. The Student Handbook includes the essential material that each student is expected to learn: laws and rules governing firearms ownership and possession, legal aspects of liability and use of deadly force, and mechanical operation and safe handling of a firearm. The Instructor’s Guide is an educational tool that will guide the instructor in conducting each course, by identifying the specific educational objectives of each lesson and providing a list of exercises and activities that will help ensure those objectives are met. Both the Student Handbook and the Instructor’s Guide also include specific details concerning the course of fire that each student must successfully complete.

While the FTM includes lesson material on various legal aspects of firearms ownership, possession, and use (including liability and use of deadly force), the firearms training material in both the Student Handbook and Instructor’s Guide are derived from the Florida Basic Recruit Training Program’s High Liability Course used by the Florida Department of Law Enforcement (FDLE) and approved by FDLE’s Criminal Justice Standards and Training Commission (CJSTC) for use in administering firearms training to basic recruits beginning their entry into the ranks of law enforcement. Insofar as this training is the accepted standard used to prepare recruits for careers in law enforcement, it is the division’s position that this training represents the benchmark of excellence with respect to firearms training. Therefore, it is appropriate that this training be used to prepare security officers, private investigators, interns, and agency managers to carry firearms while performing regulated duties.

The FTM does not address every aspect of carrying a firearm by a licensed security officer or private investigator. Additional time should be taken to familiarize yourself with all of the equipment you will use while performing licensed activity - including holsters and magazine or speed loader pouches, etc. – and to ensure that such equipment is compatible with your firearm. Each student should, if possible, use the holster and reloading equipment he or she will be using during regulated activities when performing the course of fire exercises contained in the training program. If you are issued or purchase new or different holsters or reloading equipment in the future, you are encouraged to spend time at a firing range in order to familiarize yourself with the equipment and its operation and security features.

## Table of Contents

Introduction .....	i
Table of Contents.....	ii
28-Hour Initial Qualification Course Summary and Overview .....	iv
4-Hour Annual Handgun Requalification/Transition Course Summary and Overview .....	vii
4-Hour (Re)qualification Shotgun Course Summary and Overview .....	x
4-Hour (Re)qualification Rifle Course Summary and Overview .....	xiii

### **SECTION 1                      LEGAL**

#### **Unit 1: Legal Issues**

Lesson 1: Security Officer and Private Investigator Licensure .....	2
Lesson 2: Definitions and Legal Concepts .....	6
Lesson 3: Use of Force .....	11
Case Studies .....	15

### **SECTION 2                      FIREARMS TRAINING**

#### **Unit 1: Firearms Safety**

Lesson 1: Firearms Safety Procedures .....	21
--	----

#### **Unit 2: Firearms Familiarization**

Lesson 1: Revolver .....	24
Lesson 2: Semiautomatic Pistol .....	26
Lesson 3: Shotgun.....	30
Lesson 4: Semiautomatic Rifle/Carbine .....	33

#### **Unit 3: Ammunition Use**

Lesson 1: Ammunition Identification and Maintenance .....	36
---	----

#### **Unit 4: Fundamentals of Marksmanship**

Lesson 1: Handgun .....	40
Lesson 2: Shotgun.....	49
Lesson 3: Semiautomatic Rifle/Carbine .....	52

#### **Unit 5: Drawing and Holstering a Handgun**

Lesson 1: Drawing and Holstering a Handgun .....	56
--	----

#### **Unit 6: Loading and Unloading**

Lesson 1: Revolver .....	57
Lesson 2: Semiautomatic Pistol .....	60

Lesson 3: Shotgun.....	62
Lesson 4: Semiautomatic Rifle/Carbine .....	64
<b>Unit 7: Use of Cover</b>	
Lesson 1: Use of Cover.....	65
<b>Unit 8: Weapons Malfunctions</b>	
Lesson 1: Revolver Malfunctions .....	68
Lesson 2: Semiautomatic Pistol Malfunctions.....	70
Lesson 3: Shotgun Malfunctions .....	73
Lesson 4: Semiautomatic Rifle/Carbine Malfunctions .....	75
<b>Unit 9: Weapon Cleaning</b>	
Lesson 1: Revolver Cleaning .....	78
Lesson 2: Semiautomatic Pistol Cleaning.....	80
Lesson 3: Shotgun Cleaning .....	83
Lesson 4: Semiautomatic Rifle/Carbine Cleaning .....	85
<b>Unit 10: Survival Shooting</b>	
Lesson 1: Handgun .....	87
Lesson 2: Discretionary Shooting .....	89
<b>Appendices</b>	
Appendix A: Courses of Fire .....	92
Appendix B: Shooting Targets.....	105
Appendix C: Case Study Answers .....	106
Appendix D: Glossary.....	110

## 28-HOUR INITIAL QUALIFICATION COURSE

### SUMMARY AND OVERVIEW

#### Course Description

In order to obtain a Class “G” Statewide Firearm License, each applicant must successfully complete the 28-hour initial qualification course. This course provides students with the basic knowledge and proficiency skills needed to safely handle and shoot a handgun (revolver or semiautomatic pistol). Along with extensive educational material on firearms safety and the mechanical operation of firearms, this course also includes material on various legal aspects of firearms ownership, possession, and use. At the conclusion of the classroom portion of the 28-hour course, an examination will be administered to test the student’s mastery of content. Finally, students will be required to demonstrate proficiency in shooting a handgun by passing the course of fire outlined in this training manual.

#### Course Expectations

Upon the completion of this course, the student should be able to demonstrate the following skills and techniques:

- ❖ Identify the legal authority allowing security officers and private investigators to carry a firearm
- ❖ Identify the limitations of a security officer’s ability to carry a firearm and use deadly force
- ❖ Identify crimes that may serve as a justification for the use of deadly force
- ❖ Identify the types of liability that may result from the improper use of a firearm
- ❖ Safe weapon handling
- ❖ Identification of weapons parts and ammunition
- ❖ Weapons cleaning and maintenance
- ❖ Handgun drawing and holstering
- ❖ Weapon loading and unloading
- ❖ Basic shooting principles
- ❖ Proficiency with a firearm by shooting a qualifying score with a handgun (revolver or semi-automatic pistol)
- ❖ Proficiency for weapon handling
- ❖ Proper intervention for weapon malfunctions

#### Course Requirements

Each student is responsible for reading and reviewing all course-related material. Your instructor will discuss general rules of firearms safety, and you will be expected to strictly abide by these rules throughout the entirety of this course. You will be required to attend classroom lectures that include the topics listed below. Upon completion of the classroom portion, you must complete a written examination that covers all of the course content, and pass the exam with a minimum score of 70%. You will then meet at a firing range facility to perform practical exercises using the type and caliber of handgun with which you intend to qualify. Students are required to show a minimum proficiency

of 70% on the basic firearms course of fire. **The QUALIFICATION COURSE FOR INITIAL LICENSURE shall consist of three cycles of 48 rounds each for a total of 144 rounds to be fired** (1 practice round and 2 qualification rounds). Instructors shall record the student’s highest score out of the two qualification rounds on each student’s Certificate of Firearms Proficiency for Statewide Firearm License. If you as a student receive training that uses fewer than 144 rounds in the practical range exercises notify the Division of Licensing.

**Required Text and Materials**

- ❖ Firearms Training Manual–Student Handbook and Study Guide
- ❖ Ammunition
- ❖ Eye and Ear Protection
- ❖ Firing Range
- ❖ Flashlight
- ❖ Handguns (revolver and/or semiautomatic pistol)
- ❖ Belts, Holsters, Speedloaders and Speedloader pouches, Magazines and Magazine pouches
- ❖ Targets
- ❖ Weapon Cleaning Equipment

**Course Hours**

- ❖ 28 total hours with no more than 8 hours devoted to range training

**Hours**

Legal Aspects of the Use of Firearms .....	7
Security Officer and Private Investigator Licensure .....	1
Definitions and Legal Concepts.....	3
Use of Force .....	3
Firearms Familiarization, Mechanical Operation, and Marksmanship .....	10
Qualification Course Overview .....	1
Review and Discussion.....	2
Written Examination .....	1
Practical Exercises .....	3
Walk-thru and Dry Firing of Course .....	1
Practice and Qualification Rounds (Live Fire) .....	2
Scoring of Targets and Course Completion .....	1
<b>TOTAL.....</b>	<b>28 Hours</b>

**Course Training Schedule**

The table below is designed to identify the lessons within each section and unit that must be covered during classroom instruction of the 28-Hour Initial Qualification Course. A listing of sections, units, and lessons, can be found in the Table of Contents, pages ii – iii, of this Manual.

Section 1: Legal	All Lessons
Section 2: Firearms Training	
Unit 1: Firearms Safety	Lesson 1
Unit 2: Firearms Familiarization	Lessons 1 & 2
Unit 3: Ammunition Use	Lesson 1
Unit 4: Fundamentals of Marksmanship	Lesson 1
Unit 5: Drawing and Holstering a Gun	Lesson 1
Unit 6: Loading and Unloading	Lessons 1 & 2
Unit 7: Use of Cover	Lesson 1
Unit 8: Weapons Malfunctions	Lessons 1 & 2
Unit 9: Weapon Cleaning	Lessons 1 & 2
Unit 10: Survival Shooting	<b>Optional</b>

Firearms Training  
Required Material

This bookmark, found throughout the manual, denotes required lessons for inclusion in the 28-hour certification course for Class “G” licensure.

**4-HOUR ANNUAL HANDGUN REQUALIFICATION**  
**OR TRANSITION COURSE**  
**SUMMARY AND OVERVIEW**

**Course Description**

In order to remain eligible to continue to carry a Class “G” license, during each 12-month period of the two-year term of a Class “G” license, including the first 12-month period after the license was initially issued to the license holder, a Class “G” licensee must successfully complete 4 hours of range and classroom training taught by a Class “K” firearms instructor.

Additionally, a Class “G” licensee whose job duties require him or her to carry a firearm of a type and caliber different from or in addition to the firearm upon which he or she is qualified, must take a 4-hour training class specific to that firearm type and caliber. This 4-hour course may be taken to satisfy a Class “G” licensee’s 4-hour annual requalification training or as a transition course to a different type or caliber of handgun.

**Note:** In addition to completing the annual requalification training required to remain eligible for a Class “G” license, a licensee who has also qualified to carry other types and calibers of approved firearms must complete annual requalifying training for each type and caliber of firearm he or she carries while performing regulated activities.

**Course Expectations**

Upon the completion of this course, you should be able to demonstrate the following skills and techniques:

- ❖ Identify updates in law applicable to Class “G” licensure
- ❖ Re-familiarize yourself with use of force parameters
- ❖ Re-familiarize with use of cover and the difference between cover and concealment
- ❖ Safe weapon handling
- ❖ Identification of weapons parts and ammunition
- ❖ Weapon cleaning and maintenance
- ❖ Handgun drawing and holstering
- ❖ Weapon loading and unloading
- ❖ Basic shooting principles
- ❖ Proficiency with a firearm by shooting a qualifying score with a handgun (revolver or semi-automatic pistol)
- ❖ Proficiency for weapon handling
- ❖ Proper intervention for weapon malfunctions



**Course Requirements**

Each student is responsible for reading and reviewing all course-related material. Your instructor will discuss general rules of firearms safety, and you will be expected to strictly abide by those rules throughout the entirety of this course. You will be required to attend classroom lectures that include the topics listed below. Upon completion of the classroom portion you must complete a written examination that covers all of the course content, and pass the exam with a minimum score of 70%.

You will then meet at a firing range facility to perform practical exercises using the type and caliber of handgun with which you intend to qualify. Students are required to show a minimum proficiency of 70% on the basic firearms course of fire. Students will fire for qualification using the department approved course as found in Appendix A (Handgun). Instructors will plan to have students fire three strings of 48 rounds (1 practice round and 2 qualification rounds) for a total of 144 rounds. A student qualifying on any of the rounds of fire will not be required to shoot additional strings, and will be allowed to use that qualifying score for certification. A student not qualifying at the end of 3 strings of fire will fail and such failure will be noted by the instructor on the Certificate of Firearms Proficiency. Instructors will complete scoring of targets, recording of scores, and issuance of Certificates of Firearms Proficiency, at the completion of the course.

**Required Text and Materials**

- ❖ Firearms Training Manual–Student Handbook and Study Guide
- ❖ Ammunition
- ❖ Eye and Ear Protection
- ❖ Firing Range
- ❖ Flashlight
- ❖ Handguns (revolver and/or semiautomatic pistol)
- ❖ Belts, Holsters, Speedloaders and Speedloader pouches, Magazines and Magazine pouches
- ❖ Targets
- ❖ Weapon Cleaning Equipment

**Course Hours**

	<b><u>Hours</u></b>
Legal Aspects of the Use of Firearms .....	(1)
Firearms Familiarization, Mechanical Operation, and Marksmanship .....	(1)
Written Examination .....	(.5)
Practical Exercise, Walk-Through/Dry Fire of Qualification Course .....	(.5)
Requalification (Live Fire) .....	(1)
<b>TOTAL.....</b>	<b>4 Hours</b>

**Course Training Schedule**

The table below is designed to identify the lessons within each section and unit required to be covered during classroom instruction of the 4-Hour Annual Handgun Requalification or Transition Course. A listing of sections, units, and lessons can be found in the Table of Contents, pages ii – iii, of this Manual.

Section 1: Legal	All Lessons
Section 2: Firearms Training	
Unit 1: Firearms Safety	Lesson 1
Unit 2: Firearms Familiarization	Lessons 1 & 2
Unit 3: Ammunition Use	Lesson 1
Unit 4: Fundamentals of Marksmanship	Lesson 1
Unit 5: Drawing and Holstering a Gun	Lesson 1
Unit 6: Loading and Unloading	Lessons 1 & 2
Unit 7: Use of Cover	Lesson 1
Unit 8: Weapons Malfunctions	Lessons 1 & 2
Unit 9: Weapon Cleaning	Lessons 1 & 2
Unit 10: Survival Shooting	Optional

## **4-HOUR (RE)QUALIFICATION SHOTGUN COURSE**

### **SUMMARY AND OVERVIEW**

#### **Course Description**

A Class “G” licensee whose job duties require him or her to carry a shotgun must successfully complete this 4-hour qualification course on an annual basis. The 28-hour initial firearms course is a pre-requisite to taking the shotgun (re)qualification course. Further, a licensee must continue to qualify annually with his or her primary handgun in order to use a shotgun during the course of regulated activities.

#### **Course Expectations**

Upon the completion of this course, the student should be able to demonstrate the following skills and techniques:

- ❖ Safe shotgun handling
- ❖ Identification of shotgun parts and ammunition
- ❖ Shotgun cleaning and maintenance
- ❖ Shotgun loading and unloading
- ❖ Basic shotgun shooting principles
- ❖ Proficiency with a shotgun by shooting a qualifying score while exhibiting proper shotgun handling
- ❖ Proper intervention for shotgun malfunctions

#### **Course Requirements**

Each student is responsible for reading and reviewing all course-related material. Your instructor will discuss general rules of firearms safety, and you will be expected to strictly abide by those rules throughout the entirety of this course. You will be required to attend classroom lectures that include the topics listed below. Upon completion of the classroom portion you must complete a written examination that covers all of the course content, and pass the exam with a minimum score of 70%.

You will then meet at a firing range facility to perform practical exercises. Students are required to show a minimum proficiency of 70% on the basic firearms course of fire. Students will fire for qualification using the department approved course as found in Appendix A (Shotgun). For initial qualification, instructors will plan to have students fire three strings of 8 rounds (1 practice round and 2 qualification rounds) for a total of 24 rounds. For requalification, a student qualifying on any of the rounds of fire will not be required to shoot additional strings, and will be allowed to use that qualifying score for certification. A student not qualifying at the end of 3 strings of fire will fail and such failure will be noted by the instructor on the Certificate of Firearms Proficiency. Instructors will complete scoring of targets, recording of scores, and issuance of Certificates of Firearms Proficiency, at the completion of the course.

**Required Text and Materials**

- ❖ Firearms Training Manual–Student Handbook and Study Guide
- ❖ Ammunition
- ❖ Eye and Ear Protection
- ❖ Firing Range
- ❖ Flashlight
- ❖ Shotgun
- ❖ Targets
- ❖ Weapon Cleaning Equipment

**Course Hours**

	<b><u>Hours</u></b>
Firearms Familiarization, Mechanical Operation, & Marksmanship .....	(2.5)
Written Examination .....	(.5)
Practical Exercise, Walk-thru/Dry Fire of Qualification Course.....	(.5)
(Re)qualification (Live Fire).....	(.5)
<b>TOTAL.....</b>	<b>4 Hours</b>

### Course Training Schedule

The table below is designed to identify the lessons within each section and unit, required to be covered during classroom instruction of the 4-Hour (Re)qualification Shotgun Course. A listing of sections, units, and lessons can be found in the Table of Contents, pages ii – iii, of this Manual.

<b>Section 1: Legal</b>	All Lessons
<b>Section 2: Firearms Training</b>	
Unit 1: Firearms Safety	Lesson 1
Unit 2: Firearms Familiarization	Lesson 3
Unit 3: Ammunition Use	Lesson 1
Unit 4: Fundamentals of Marksmanship	Lesson 3
Unit 5: Drawing and Holstering a Gun	N/A
Unit 6: Loading and Unloading	Lesson 3
Unit 7: Use of Cover	Lesson 1
Unit 8: Weapons Malfunctions	Lesson 3
Unit 9: Weapon Cleaning	Lesson 3
Unit 10: Survival Shooting	Optional

## **4-HOUR (RE)QUALIFICATION RIFLE COURSE**

### **SUMMARY AND OVERVIEW**

#### **Course Description**

A Class “G” licensee whose job duties require him or her to carry a rifle, must successfully complete this 4-hour qualification course on an annual basis. The 28-hour initial firearms course is a pre-requisite to taking the rifle (re)qualification course. Further, a licensee must continue to qualify annually with his or her primary handgun in order to use a rifle during the course of regulated activities.

#### **Course Expectations**

Upon the completion of this course, the student should be able to demonstrate the following skills and techniques:

- ❖ Safe rifle handling
- ❖ Identification of rifle parts and ammunition
- ❖ Rifle cleaning and maintenance
- ❖ Rifle loading and unloading
- ❖ Basic rifle shooting principles
- ❖ Proficiency with a rifle by shooting a qualifying score while exhibiting proper rifle handling
- ❖ Proper intervention for rifle malfunctions

#### **Course Requirements**

Each student is responsible for reading and reviewing all course-related material. Your instructor will discuss general rules of firearms safety, and you will be expected to strictly abide by those rules throughout the entirety of the course. You will be required to attend classroom lectures that include the topics listed below. Upon completion of the classroom portion you must complete a written examination that covers all of the course content, and pass the exam with a minimum score of 70%.

You will then meet at a firing range facility to perform practical exercises. Students are required to show a minimum proficiency of 70% on the basic firearms course of fire. Students will fire for qualification using the Department approved course as found in Appendix A (Rifle). For initial qualification, instructors will plan to have students fire three strings of 30 rounds (1 practice round and 2 qualification rounds) for a total of 90 rounds. For requalification, a student qualifying on any of the rounds of fire will not be required to shoot additional strings, and will be allowed to use that qualifying score for certification. A student not qualifying at the end of 3 strings of fire will fail and such failure will be noted by the instructor on the Certificate of Firearms Proficiency. Instructors will complete scoring of targets, recording of scores, and issuance of Certificates of Firearms Proficiency, at the completion of the course.

**Required Text and Materials**

- ❖ Firearms Training Manual–Student Handbook and Study Guide
- ❖ Ammunition
- ❖ Eye and Ear Protection
- ❖ Firing Range
- ❖ Flashlight
- ❖ Rifle
- ❖ Targets
- ❖ Weapon Cleaning Equipment

**Course Hours**

	<b><u>Hours</u></b>
Rifle Familiarization, Mechanical Operation, & Marksmanship .....	(2.5)
Written Examination .....	(.5)
Practical Exercise, Walk-Through/Dry Fire of Qualification Course .....	(.5)
(Re)qualification (Live Fire).....	(.5)
<b>TOTAL.....</b>	<b>4 Hours</b>

**Course Training Schedule**

The table below is designed to identify the lessons within each section and unit, required to be covered during classroom instruction of the 4-Hour (Re)qualification Rifle Course. A listing of sections, units, and lessons can be found in the Table of Contents, pages ii – iii, of this Manual.

<b>Section 1: Legal</b>	All Lessons
<b>Section 2: Firearms Training</b>	
Unit 1: Firearms Safety	Lesson 1
Unit 2: Firearms Familiarization	Lesson 4
Unit 3: Ammunition Use	Lesson 1
Unit 4: Fundamentals of Marksmanship	Lesson 4
Unit 5: Drawing and Holstering a Gun	N/A
Unit 6: Loading and Unloading	Lesson 4
Unit 7: Use of Cover	Lesson 1
Unit 8: Weapons Malfunctions	Lessons 4
Unit 9: Weapon Cleaning	Lessons 4
Unit 10: Survival Shooting	<b>Optional</b>



# **SECTION 1**

## **LEGAL**

**UNIT 1: LEGAL ISSUES**Firearms Training  
Required Material**LESSON 1 | Security Officer and Private Investigator Licensure****OBJECTIVES**

- ❖ Identify the legal authority allowing private investigators and security officers to carry firearms.
- ❖ Identify the limitations of a private investigator or security officer's ability to carry a firearm.
- ❖ Identify the rules governing the licensing and carrying of a firearm by private investigators and security officers.

**LESSON GOAL:** At the end of this lesson, the student should comprehend and be able to explain the statutory and legal authority giving security officers and private investigators the ability to carry firearms.

**Text/Materials/Instructional Aids**

- ❖ Chapter 493, Florida Statutes
- ❖ Chapter 5N-1, Florida Administrative Code

Chapter 493, Florida Statutes, establishes the requirements for individuals and agencies providing private investigation and private security services in the State of Florida. Insofar as you will be working in one of these industries, it is imperative that each of you have a complete understanding of every facet of this chapter of law. Below are excerpts from specific sections of Chapter 493, Florida Statutes, which pertain directly to firearms along with a brief summary of the contents of these sections.

**493.6105 Initial application for license.**

This section includes the basic application and eligibility requirements for anyone applying for licensure under Chapter 493, Florida Statutes. A person applying for a Class "G" license must submit the original white page from the Certificate of Firearms Proficiency (CFP) (Form FDACS-16005) indicating completion of a 28-hour training class administered by a Class "K" Firearms Instructor. A student whose CFP is lost or damaged, should contact his/her firearms instructor to receive a duplicate copy.

**493.6111 License; contents; identification card.**

Licenseses must carry their individual license while on duty. In addition, each licensee's employing agency is required by law to issue an identification card that shall also be in the possession of the license holder while on duty.

**493.6113 Renewal application for licensure.**

Class "G" licensees must complete four hours of requalifying training during each year that the license is valid. This requalifying training must be COMPLETED and REPORTED to the Division of Licensing ANNUALLY. The yearly anniversary of the license's expiration date marks the calendar year during which training must be completed and reported. (For example, if a license expires on April 8, then annual training must be completed and reported from April 8 of one year to April 8 of the next year.)

**493.6115 Weapons and firearms**

The Class “G” Statewide Firearm License is a COMPANION license. It can be carried only by a person who holds another license (security officer, private investigator, intern, or manager) who also needs to carry a firearm in connection with regulated duties.

*Note to Student: Section 493.6115 establishes the specific authority for security officers, private investigators, interns, and managers to carry a firearm in connection with their regulated duties.*

The weapon or firearm carried by a Class “G” licensee shall be encased *in view* at all times. *Note the exceptions:* private investigators and private investigator interns; or Class “D” and “G” licensees performing “limited, special assignment duties” pursuant to section **493.6305(3)**, Florida Statutes, may carry a concealed firearm.

Section 493.6115(6) authorizes licensees to carry the following caliber handguns while performing duties authorized under this chapter:

- ❖ .38 caliber revolver
- ❖ .380 caliber or 9 millimeter semiautomatic pistol
- ❖ .357 caliber revolver with .38 caliber ammunition only
- ❖ .40 caliber handgun
- ❖ .45 ACP handgun

A licensee may not carry more than two firearms upon her or his person when performing her or his duties.

A licensee may only carry a firearm of the specific type and caliber with which she or he is qualified pursuant to the firearms training referenced in section 493.6115(8), or in accordance with the training documentation submitted pursuant to section 493.6113(3)(b), FS.

Whenever a Class “G” license holder discharges a firearm in the course of performing regulated duties, the licensee and the agency that employs the licensee must submit to the Division of Licensing an explanation describing the nature of the incident, the necessity for using a firearm, and a copy of any report prepared by a law enforcement agency in connection with the discharge incident. Licensees must utilize the Firearms Incident Report (Form FDACS-16001) to report *any* duty related firearms discharge.

**493.6118 Grounds for disciplinary action**

This is the part of the law that establishes grounds for disciplinary action against licensees, agencies, or applicants regulated by Chapter 493, Florida Statutes, or any unlicensed person engaged in activities regulated under this chapter. Licensees should familiarize themselves with potential disciplinary issues.

One of the most common violations found by the Division of Licensing is the failure of a licensee to have his or her valid license in their possession while on duty.

**493.6120      Violations; penalty**

Engaging in regulated activities without being properly licensed can result in serious criminal consequences. It is important for licensed persons to ensure that all licenses are kept current.

It is a 3<sup>rd</sup> degree felony to knowingly possess, issue, cause to be issued, sell, submit, or offer a fraudulent training certificate, proficiency form, or other official document that declares an applicant to have successfully completed any course of training required for licensure under this chapter when that person either knew or reasonably should have known that the certificate, form, or document was fraudulent.

**493.6121      Enforcement; investigation**

The department has the authority to investigate violations of Chapter 493, Florida Statutes, and the conduct of a licensee in the performance of his or her duties.

**Rule Chapter 5N-1: PRIVATE INVESTIGATIVE, SECURITY AND REPOSSESSION ACTIVITIES, SCHOOLS**

In addition to establishing the legal authority for properly licensed security officers and private investigators to carry firearms on duty, Chapter 493, Florida Statutes, grants the Department of Agriculture and Consumer Services the authority to create rules regulating the conduct and training of security officers and private investigators. To that end, the Division of Licensing has created a number of rules found in Chapter 5N of the Florida Administrative Code that relate to the possession and use of firearms by licensed security officers and private investigators. As a licensed security officer or private investigator you are subject to the requirements of Rule 5N-1, FAC, and can be disciplined for violating the provisions contained within this rule. For more information or to view Rule 5N-1 in its entirety, please visit:

<https://www.flrules.org/gateway/ChapterHome.asp?Chapter=5N-1>

**5N-1.113      Disciplinary Guidelines; Range of Penalties; Aggravating and Mitigating Circumstances**

This rule establishes progressive disciplinary guidelines for Chapter 493, Florida Statutes. The firearms-related violations include the following:

- ❖ Carrying a weapon that is not required by the licensee's duties
- ❖ Carrying a firearm or ammunition not authorized by the division
- ❖ Failing to report a firearm discharge incident to the division
- ❖ Negligent use of a firearm
- ❖ Violation of state law

**5N-1.129 Ammunition**

Licensed agencies shall allow Class “G” license holders to use only factory ammunition of a type and load which is appropriate for the location and duty requirements of armed employees. The following types of ammunition are prohibited:

- ❖ Glaser-type or any other pre-fragmented type bullets
- ❖ Exploding bullets
- ❖ Full metal jacket /full metal case bullets (this can be used in semi-automatic pistols only)
- ❖ Teflon-coated (ktw-type) or any other type of armor piercing bullets
- ❖ Full wadcutter bullets (except on the firing range)
- ❖ Reloaded ammunition (except on the firing range)

**5N-1.130 Firearms**

An armed security officer cannot carry a firearm while on duty unless authorized to do so by her or his employer as being required by and in connection with assigned duties.

This rule should be reviewed in its entirety as it contains very carefully defined scenarios in which an armed security officer leaving his or her post is not required to disarm. Three such scenarios are as follows:

1. An armed officer can carry a firearm outside a client's property line if the carrying of the firearm is in connection with the security duties performed for the client and is in within a half-mile radius of the client's property.
2. An armed officer can travel directly to and from home to reach and leave a client's site at which armed security services have been requested by the client, provided that the licensee is in uniform and has written direction or approval from her or his employing agency.
3. An armed officer can perform tasks during duty hours (such as refueling an agency-owned vehicle, purchasing carry-out food or beverage, or taking a restroom break) provided that such activities are carried out within a two-mile radius of the licensee's assigned duty post.

*Note to Student: As a Class “G” license holder, you should discuss the provisions of Rule 5N-1.130 with your employer once hired. Agency management will need to make a policy decision as to whether agency employees will be allowed to carry weapons in accordance with guidelines set forth in this rule. A “G” license holder must have express written authority from his or her employer to carry a firearm while traveling to or from the armed security post.*

**5N-1.132 Firearms Training**

This rule provides Class “G” applicants and licensees guidance regarding initial and annual firearms training requirements, and training requirements to transition to other types and calibers of firearms. Guidance is also provided to Class “K” licensees regarding use of the Certificate of Firearms Proficiency for Statewide Firearms License and instructor record keeping requirements.

**LESSON 2 | Definitions and Legal Concepts**Firearms Training Required  
Material**OBJECTIVES**

- ❖ Identify differences between criminal and civil liability.
- ❖ Identify differences between misdemeanor and felony offenses.
- ❖ Identify elements of negligence.
- ❖ Identify elements of “assault” & “battery.”

**LESSON GOAL:** At the end of this lesson, the student should comprehend and be able to explain the basic legal terminology and definitions associated with criminal and civil liability as these relate to licensed security officers and private investigators, know the elements of certain crimes and be able to identify these crimes from a fact based scenario.

**Text/Materials/Instructional Aids**

- ❖ Chapters 775, 782, 784, 787, 810 and 812, FS
- ❖ Case Studies Material

**Definitions:**

**Aggravated Assault** is an assault with a deadly weapon without intent to kill; OR with intent to commit a felony. *See* s. 784.021, FS.

**Aggravated Battery** is a battery where the person committing the battery: intentionally or knowingly causes great bodily harm, permanent disability or permanent disfigurement; OR uses a deadly weapon; OR the victim was pregnant and the offender knew or should have known that the victim was pregnant. *See* s. 784.045, FS.

**Assault** is an intentional, unlawful threat by word or act to do violence to the person of another coupled with an apparent ability to do so, and doing some act which creates a well-founded fear in such other person that such violence is imminent. *See* s. 784.011(1), FS. (*Note: Simple assault is NOT a forcible felony*)

**Battery** occurs when a person actually and intentionally touches or strikes another person against the will of the other; OR intentionally causes bodily harm to another. *See* s. 784.03(1)(a), FS. (*Note: Simple battery is NOT a forcible felony*)

**Burglary** means the entering of a dwelling, structure, or conveyance with the intent to commit an offense therein, unless at the time the premises are open to the public or the defendant is licensed or invited to enter, OR if having been previously invited or licensed to enter remains in the dwelling, structure, or conveyance, either surreptitiously or after permission to remain has been withdrawn, with intent to commit an offense, OR to commit or attempt to commit a forcible felony as defined in s. 776.08, FS. *See* s. 810.02 (1)(b), FS

**Carjacking** is the taking of a motor vehicle from the person or custody of another with the intent to permanently or temporarily deprive the person or owner of the motor vehicle, and in doing so there is the use of force, violence, assault, or putting in fear. *See* s. 812.133(1), FS.

**Forcible Felony** means treason; murder; manslaughter; sexual battery; carjacking; home-invasion robbery; robbery; burglary; arson; kidnapping; aggravated assault; aggravated battery; aggravated stalking; aircraft piracy; unlawful throwing, placing, or discharging of a destructive device or bomb; and any other felony which involves the use or threat of physical force or violence against any individual. *See* s. 776.08, FS.

**Kidnapping** is forcibly, secretly, or by threat confining, abducting, or imprisoning another person against his/her will with the intent to hold for ransom, reward or as a human shield or hostage, commit or facilitate the commission of a felony, inflict bodily harm or terrorize the victim or another person, or interfere with the performance of any governmental or political function. *See s. 787.01(1)(a), FS.*

**Manslaughter** is the killing of a human being by the act, procurement, or culpable negligence of another, without the lawful justification according to Chapter 776. *See s. 782.07 (1), FS.* A licensee who uses deadly force when such force is not justified under the law could be subject to criminal prosecution for manslaughter, aggravated assault, or other serious charges depending on the circumstances.

**Robbery** is the taking of money or property from person or custody of another with the intent to permanently or temporarily deprive the person or owner of the money or other property, when in the course of taking there is the use of force, violence, assault, or putting in fear. *See s. 812.13(1), FS.*

**Liability** occurs when a licensee fails to conduct him or herself within the standard of care for a security officer or private investigator, and that failure was the direct and proximate cause of an injury suffered.

**Standard of Care** is the recognized and accepted operating procedure, principle, or practice for an occupation or profession.

**Tort** is a civil wrong where an aggrieved party can be made whole through the awarding of damages.

## Liability

There are two general areas of liability: criminal liability and civil liability. **Criminal Liability** occurs when a person violates a criminal law contained in Florida Statutes. **Civil Liability** occurs when a person is responsible for a civil wrong [or tort] to another. Penalties include monetary damages and restraining orders. This is based upon the accepted doctrine that a licensee owes to citizens a certain standard of care in his or her performance of duty. Negligence occurs and civil liability attaches when, through an act or omission, the employee fails to conform his or her behavior to that reasonable standard.

## Criminal Liability

In order to understand the concepts and ideas regarding the justifiable use of deadly force as they pertain to security officers and private investigators, one must have a basic working knowledge of some criminal legal concepts. There are two independent bodies of criminal law that can be at play in Florida. One is the violation of state criminal law as found in Florida Statutes, and the other is the violation of federal law as found in the United States Federal Code. This training manual focuses exclusively on state law topics. If, as a security officer or private investigator, you are working at a federally regulated facility or working for a municipality under the municipality's state law authority, please be aware that additional federal laws regarding crimes, civil liability, and the appropriate use of deadly force may apply. A security officer or private investigator working in these environments should seek additional training and direction from his or her employer regarding these topics.

**Criminal Liability** occurs when there is a violation of a criminal law. Penalties include incarceration, probation, and monetary fines. In Florida there are two types of crimes under state law: felonies and misdemeanors.

A **Felony** is any crime committed for which the maximum penalty includes possible incarceration in a state prison for more than one year. *See s. 775.08(1), FS*

A **Misdemeanor** is any crime for which the maximum penalty includes possible incarceration of one year or less in a county jail. *See s. 775.08(2), FS*

*Note to Student: State Criminal Prosecution - A licensee, merely because he or she is licensed, is not immune to prosecution for criminal conduct. The improper use or unjustified use of deadly force by a licensee may, therefore, give rise to prosecution for the crimes of assault and battery, assault with a deadly weapon, manslaughter, or even murder.*

As a security officer or private investigator you may be confronted with persons engaging in suspicious behavior; that is someone acting in a manner that is out of the ordinary given a particular situation, place, or time of day. While suspicious behavior is not criminal in and of itself, it is important for the security officer or private investigator to be aware of some general criminal law violations so the officer or investigator knows not only what to report to law enforcement, but central to this training curriculum, when the use of deadly force may be allowed under the law. Contained below are several crimes that may be encountered by security officers and private

investigators.

**PLEASE NOTE** that the crimes discussed in this training material are not exhaustive of all crimes found in Florida Statutes, nor do all crimes discussed serve as a justified basis for the use of deadly force.

Criminal Liability regarding firearm use and possession by security officers and private investigators is primarily found in a few different scenarios. The first involves the carrying of a firearm outside the scope allowed under Chapter 493, where the officer or investigator is carrying a firearm off duty in a manner or place not authorized by law, or on a job site where the employer has not expressly authorized carrying of the firearm. This could expose the officer or investigator to misdemeanor or felony charges. The second occurs if the officer or investigator pulls his/her firearm from its holster without a valid lawful reason. Here the officer or investigator could be charged with improper exhibition of a firearm under Section 790.10, Florida Statutes. Next, if an officer or investigator discharges a firearm either intentionally or in a reckless manner, without a valid lawful reason, the officer or investigator could be charged for crimes ranging from reckless discharge of a firearm, aggravated assault/battery, manslaughter, or murder. The actual criminal charge in these situations is largely dependent on the resulting harm from the firearm discharge.

### Civil Liability

In addition to knowing basic criminal offenses, security officers and private investigators need to know legal concepts surrounding the topic of civil liability. Liability, as we will see in going through this training material, comes in many forms and is found in virtually every aspect of a security officer or private investigator's daily duties.

Every officer, investigator, or business must act in a reasonable and safe manner when interacting with its clients, patrons, and the general public. This duty, or **standard of care**, is the level of care that society expects of us as we go through our day. For example, when you drive a car down the street you expect that others will obey traffic laws and be alert while driving. The standard of care while driving is to operate a motor vehicle in a safe and alert manner based on road and traffic conditions. If a driver runs through a red light or speeds through a school zone, the driver has breached the standard of care that we as a society expect from all drivers. If that same driver hits another vehicle because the driver ran the stop light or was speeding in the school zone, then that driver is likely negligent. If the driver's negligence is responsible for damage to another person, then the driver will be liable or responsible for the damages caused.



**Negligence** is the failure of a licensee or company to use reasonable care in a situation where the failure results in harm to another. The elements of negligence include:

- ❖ Duty to act with care
- ❖ Breach of that duty
- ❖ Breach was the cause or proximate cause of
- ❖ Injury or harm resulting in damages

Licensees are highly vulnerable in two areas of civil liability: negligent use of deadly force and intentional use of excessive force. With respect to negligence, the law requires that licensees conduct their activities in a fashion that does not expose others to an unreasonable risk of harm. A licensee is, therefore, called upon to weigh the consequences of his or her actions carefully and ascertain whether the utility or benefit of his or her conduct will be overshadowed by the risk of harm to other persons.

A risk is unreasonable and an act is negligent if a reasonable and prudent person would recognize the act as involving a risk, and determine that risk to be of such a magnitude as to outweigh the possible benefit of the act. Courts, in attempting to assess liability, will balance the immediate necessity of a shooting against the potential danger created by use of the weapon.

Incidents which present clearer examples of negligence involve the reckless, indiscriminate, and random use of a firearm, and shooting at fleeing suspects. In many firearm discharge instances where a licensee has been found negligent, the licensee had no justification to remove his or her firearm from their holster.

When a licensee discharges a firearm, he or she has no control over where the bullet goes once it leaves the muzzle. This is especially true when firing warning shots. The laws of gravity apply to bullets as well as apples; what goes up must come down and the licensee has no control over where a bullet will land. Warning shots are also subject to ricochets which can cause unintended property damage and personal injury or death.

The intentional use of a firearm under mistaken or misperceived facts is perhaps the most treacherous area of civil liability for licensees. Licensees are clearly not legally or morally required to wait until a suspect actually shoots at either the licensee or someone else in order to use deadly force. However, the highest degree of care and diligence must be exercised by the licensee to ensure that his or her perceptions are indeed valid. A typical situation involves the suspect making a sudden suspicious move toward a potential hiding place for a weapon, or the sudden display of a suspicious object which under the circumstances appears to be a weapon. In some of these instances, licensees have employed deadly force and have been exonerated by the subsequent discovery of a weapon. In others, however, the “weapon” has turned out to be a harmless object such as a wallet or identification papers. A licensee who acts under a reasonable belief that he or she is facing potentially deadly force, and uses their weapon as a last resort, should incur no liability.

*Note to Student: If a licensee, through the improper use of deadly or non-deadly force, kills someone, she may be liable to the deceased's survivors under another civil action known as Wrongful Death. Since courts have held that an assault and battery action terminates only with the death of the victim, a Wrongful Death action provides a vehicle by which survivors may recover damages for the deceased's pain and suffering, medical expenses, and loss of earnings potential.*

Finally, the accidental discharge of a firearm may produce a negligence suit in one of two ways: accidental discharge of a firearm pointed at a suspect, or improper handling of a firearm. A licensee may be liable for an accidental discharge if he or she improperly draws his or her firearm and it subsequently discharges, accidentally striking a suspect or a bystander. An example would be an instance in which a licensee improperly draws their firearm at the scene of a disorderly person complaint when no deadly force has been used or threatened, then trips, causing the firearm to fire, wounding a bystander. A licensee may be liable for improper handling if the licensee handles a firearm in an unsafe manner resulting in the discharge of the firearm.

Elements and concepts associated with civil liability include:

**Vicarious Liability:** The attachment of liability to another person (supervisor of licensee) for the wrongful acts of a subordinate whose actions he or she orders, directs, or approves. Vicarious liability can also be through act (directing) or an omission (failure to act thus giving tacit approval). Vicarious liability may result in negligence being assessed against a supervisor or agency owner for insufficient, improper or inadequate training or supervision of the licensee.

*Note to Student: Civil Action in State Court - Traditionally, the most common action in response to the perceived improper use of force was a lawsuit against the licensee for the harmful or offensive intentional, unpermitted, and unjustified bodily contact. Under a given set of facts, a licensee may be justified in using an amount of force short of deadly force. If he exceeds this permitted level of force, he may be liable in damages for whatever injury was inflicted.*

**Negligent Entrustment:** An agency head or supervisor charged with the responsibility of equipping licensees with firearms might be liable under this legal theory if he or she knew, or should have known, that a particular licensee was incompetent and, nevertheless, provided him or her with a dangerous instrument, specifically, a firearm. If, as a result of providing the incompetent licensee with the firearm, an innocent third party is injured, liability will attach.

This action addresses those situations in which a licensee who fails to meet proficiency standards is allowed to carry a firearm and subsequently negligently injures someone with that firearm. Clearly

under these circumstances, liability will attach to an employer who allows the licensee to retain his firearm and possibly to a supervisor who fails to take appropriate action regarding the licensee's continued use of that firearm.

**Negligent Assignment:** Negligent assignment may be charged in instances in which a licensee, under investigation for misuse of a firearm, is allowed to remain on duty during which time he or she again uses deadly force in an improper manner. An employer who has been put on notice of the possibility of incompetency by a first instance of firearm misuse, and who fails to temporarily remove the licensee from a position in which he may again act negligently, may be liable for that failure to act. The prudent employer must, under such conditions, reassign a licensee who has used deadly force to an unarmed position until it has been conclusively established that he/she did so, in a justifiable and proper manner.

**LESSON 3 | Use of Force**Firearms Training Required  
Material**OBJECTIVES**

- ❖ Identify the statutory authority for the use of deadly force.
- ❖ Identify the term “reasonably believes” as this relates to the use of deadly force.
- ❖ Identify “irrational belief” as this relates to deadly force.
- ❖ Identify what constitutes a “forcible felony.”
- ❖ Identify the requirements in Florida Statutes for storing a firearm.
- ❖ Identify the main tenets of deadly force law.
- ❖ Identify what constitutes deadly force.

**LESSON GOAL:** At the end of this lesson, the student should be able to understand and explain when the use of physical force, to include deadly force, is legally justified, and the statutory authority that provides a legal basis for a licensed security officer or private investigator to use such force. The use of deadly force is a complex issue with many legal, social, and public safety concerns.

**Text/Materials/Instructional Aids**

- ❖ Chapters 776 and 782, Florida Statutes
- ❖ Case Studies Material

The decision by a licensed security officer or private investigator to use physical force against another person is a very serious matter. These decisions often occur with little or no warning, requiring officers or investigators to react quickly, and sometimes with limited information. The sudden nature of many use of force incidents require the officer or investigator to prepare mentally well before a use of force situation is present; identifying areas of concern within the physical layout of the officer’s surroundings, and walking through [in the officer’s mind] the potential responses and outcomes to various physical

threats that may be presented. A subset of the use of physical force is the use of deadly force. This training material is geared toward providing security officers and private investigators a basic understanding of when, under the laws of the State of Florida, the use of deadly force is allowed and the limitations associated with the use of such force. It is important to understand that even though the law may provide a defense for the use of deadly force, and that defense may apply to a given situation, the use of deadly force should only be used as a last resort.

Chapter 776, Florida Statutes, governs the use of physical force by security officers and private investigators. Security officers and private investigators have the same rights and abilities to use physical force, including deadly force, as every private citizen in the State of Florida. Security officers and private investigators do not possess additional or enhanced authority to use physical force beyond the statutes enumerated below. Security officers and private investigators are not law enforcement or correctional officers, and are thus not afforded defenses available to law enforcement or correctional officers in the use of force context.

The primary statutory authority relied upon by security officers and private investigators in using physical force are contained in sections 776.012 and 776.031, Florida Statutes. A security officer or private investigator should be familiar with these statutory provisions and understand when and to what extent, the lawful use of physical force is available.

*Note to Student: Licensed security officers and private investigators have the same authority to use force [to include deadly force] as any private citizen. There are no special provisions giving a licensed security officer or private investigator additional authority to use force including deadly force. Licensed security officers and private investigators are not law enforcement or correctional officers and thus defenses available to law enforcement or correctional officers in the use of force are not available to a security officer or private investigator.*

***Deadly force includes the firing of a firearm in the direction of a person, even though no intent exists to kill or inflict great bodily harm, or the firing of a firearm at a vehicle in which a person is riding.***

There are two basic scenarios where a security officer or private investigator can use deadly force. One is when the officer reasonably believes that the use of deadly force is needed to stop a person from killing or causing great bodily harm to the officer or another person. The other is when deadly force is used to prevent the imminent commission of a forcible felony.

**Deadly force** means force which a reasonable person would consider likely to cause death or serious bodily

harm.

**Reasonable force:** The type and amount of force that a reasonably prudent person would deem appropriate under the circumstances based on the situation and threat presented. Reasonableness is determined by evaluating what was known to the person using force at the time the force was used. This includes elements like the physical attributes of both the person using force as well as the subject of the use of force, known background of the subject of the use of force by the person using force, knowledge about the subject's actions prior to the use of force occurring, and environmental factors such as location and time of day. As security officers and private investigators, each of you should be aware to the extent allowable by the particular circumstances of these subject factors in interactions with potentially hostile individuals. This will allow you to have better understanding of what options are available prior to a use of force incident occurring.

- ❖ **Example:** While it may be reasonable to place your hand on the shoulder of a person to prevent that person from inadvertently running into you, it would not be reasonable to push the person to the ground. Factors such as the size of the officer versus the size of the subject may determine how much force is reasonable in this scenario. A small officer may have to use more force to prevent a large subject from running into the officer, as compared to a large officer confronting a smaller subject.

The following excerpts from Florida law establish the specific legal conditions under which a person can justifiably use or threaten to use force in defense of a person.

### **776.012 Use or threatened use of force in defense of person**

(1) A person is justified in using or threatening to use force, except deadly force, against another when and to the extent that the person reasonably believes that such conduct is necessary to defend himself or herself or another against the other's imminent use of unlawful force. A person who uses or threatens to use force in accordance with this subsection does not have a duty to retreat before using or threatening to use such force.

(2) A person is justified in using or threatening to use deadly force if he or she reasonably believes that using or threatening to use such force is necessary to prevent imminent death or great bodily harm to himself or herself or another or to prevent the imminent commission of a forcible felony. A person who uses or threatens to use deadly force in accordance with this subsection does not have a duty to retreat and has the right to stand his or her ground if the person using or threatening to use the deadly force is not engaged in a criminal activity and is in a place where he or she has a right to be.

**Discussion:** Under section 776.012, Florida Statutes, the use of deadly force is only allowed to prevent the death or great bodily harm to the officer or another person or to prevent the commission of a forcible felony. If death or serious bodily injury or forcible felony has occurred, and there is no continued threat presented by the perpetrator, then no deadly force by the officer is allowed. For example, if a perpetrator walked up to a bystander, shot and killed the bystander,

***Note to Student: In Florida standard jury instructions, the reputation of the victim or the propensity for violence of the victim that is known to the user of deadly force and the physical abilities and capabilities of both the subject and user or force are relevant to the question of whether a particular use of force is defensible under the law.***

and then the perpetrator placed the firearm on the ground and walked away, under the law, a security officer or private investigator would not be justified in using deadly force on the perpetrator based on the murder that just occurred. We will discuss a little later what constitutes a “forcible felony.”

### **776.031 Use or threatened use of force in defense of property**

(1) A person is justified in using or threatening to use force, except deadly force, against another when and to the extent that the person reasonably believes that such conduct is necessary to prevent or terminate the other’s trespass on, or other tortuous or criminal interference with, either real property other than a dwelling or personal property, lawfully in his or her possession or in the possession of another who is a member of his or her immediate family or household or of a person whose property he or she has a legal duty to protect. A person who uses or threatens to use force in accordance with this subsection does not have a duty to retreat before using or threatening to use such force.

(2) A person is justified in using or threatening to use deadly force only if he or she reasonably believes that such conduct is necessary to prevent the imminent commission of a forcible felony. A person who uses or threatens to use deadly force in accordance with this subsection does not have a duty to retreat and has the right to stand his or her ground if the person using or threatening to use the deadly force is not engaged in a criminal activity and is in a place where he or she has a right to be.

**Discussion:** The use of deadly force in defense of property is only available to prevent the imminent commission of a forcible felony. A crime is imminent if it about to occur. This means that if a forcible felony has already occurred and has been completed, there is no justification for the use of deadly force.

### **776.08 Forcible felony**

“Forcible felony” means treason; murder; manslaughter; sexual battery; carjacking; home-invasion robbery; robbery; burglary; arson; kidnapping; aggravated assault; aggravated battery; aggravated stalking; aircraft piracy; unlawful throwing, placing, or discharging of a destructive device or bomb; and any other felony which involves the use or threat of physical force or violence against any individual.

*Note to Student: Excessive Use of Force. In terms of the legal consequences of improperly using deadly force, the claim of excessive force is most common. Stated simply, if the licensee was not justified under state law in using a firearm, his use of deadly force may subject him or her to a number of sanctions.*

Treason	876.32, F.S.
Murder	782.04, F.S.
Manslaughter	782.07, F.S.
Sexual battery	794.011, F.S.
Carjacking	812.133, F.S.
Home-invasion robbery	812.135, F.S.
Robbery	812.13, F.S.
Burglary	810.02, F.S.
Arson	806.01, F.S.
Kidnapping	787.01, F.S.
Aggravated assault	784.021, F.S.
Aggravated battery	784.045, F.S.
Aggravated stalking	784.048, F.S.
Aircraft piracy (hijacking)	860.16, F.S.
Unlawful throwing, placing, or discharging of a destructive device or bomb	552.22, F.S.

## 782.02 Justifiable use of deadly force

The use of deadly force is justifiable when a person is resisting any attempt to murder such person or to commit any felony upon him or her or upon or in any dwelling house in which such person shall be.

Every security officer or private investigator should be able to explain why he or she felt the need to use force in every situation in which force is used. Security officers and private investigators using physical force should be aware of and stay current with prevailing legal standards associated with the use of physical force.

A security officer or private investigator is generally not authorized under the law to shoot at a fleeing suspect. The only time an officer or investigator is allowed to shoot at a fleeing suspect is if that fleeing suspect is actively trying to kill or cause great bodily harm to the officer or investigator, or the fleeing suspect is committing or about to commit a forcible felony. For example if an officer engages a robbery suspect in the mall parking lot and the officer has a good faith reasonable belief based on the circumstances that the fleeing suspect is about to commit or is actively engaged in the commission of a carjacking (a forcible felony) then the officer would likely have a legal defense for the use of deadly force. But remember that any use of deadly force would only be appropriate if the use of the deadly force would not be reckless or negligent based on the circumstances. If the officer cannot safely shoot the suspect committing the forcible felony without injuring bystanders the officer should not engage the suspect.

**Stand your ground:** Stand your ground law in Florida simply means that when a person is justified in using physical force up to and including deadly force, the person does not have a duty to retreat prior to using lawful physical force.

*Note to Student: A warning shot is defined as the act of firing or a round from an operable firearm with the specific intent of having the discharged projectile NOT hit or strike any person. A “warning shot” is identified as the threatened use of deadly force under sections 776.012 and 776.031, Florida Statutes. Pursuant to Florida law a “warning shot” is only allowable if the circumstances that would otherwise warrant the use of deadly force are present. The idea that a “warning shot” is somehow a lesser amount of force used than actually shooting a person is not accurate. While the law provides a legal defense for the use of a “warning shot” security officers and private investigators should be aware that a reckless or negligent “warning shot” may expose the licensee to both criminal and civil liability. A licensee who discharges his/her firearm is ultimately responsible for where that round lands.*







**Case Study #3**

You are an armed security officer at an apartment complex. A man approaches one of the units and begins banging on the door and yelling for the resident in a very loud and aggressive tone of voice. You are aware that the resident of that apartment is not home and ask the man to leave the premises. The man turns toward you and makes several verbal threats towards you to include getting his gang member friends to shoot the place up and to burn down the apartment complex. You again instruct the man to leave and he turns as if to leave only to suddenly run up to you and strike you on the face with a closed fist. Your knees buckle and blood comes down the side of your face. The man takes up position a few feet from you and pulls his shirt open and places his arms behind his back. The man tells you he has a “Glock” and is going to “cap” you as he comes toward you. Is deadly force justified?

**Answer:** \_\_\_\_\_  
\_\_\_\_\_  
\_\_\_\_\_  
\_\_\_\_\_  
\_\_\_\_\_  
\_\_\_\_\_  
\_\_\_\_\_  
\_\_\_\_\_  
\_\_\_\_\_  
\_\_\_\_\_  
\_\_\_\_\_

**Case Study #4**

You are an armed security officer working at a large department store when you are notified by radio that a man armed with a knife just robbed the jewelry counter and headed out the east exit. You exit the north side of the store and see a man matching the description of the suspect run to a waiting car and head in your direction. You wave at the car and feel as though the driver may hit you. You draw your weapon and as the car comes closer, you dive out of the way. Is deadly force justified?

**Answer:** \_\_\_\_\_  
\_\_\_\_\_  
\_\_\_\_\_  
\_\_\_\_\_  
\_\_\_\_\_  
\_\_\_\_\_  
\_\_\_\_\_  
\_\_\_\_\_



**Case Study #6**

This case study involves a security officer discharging his firearm at a vehicle in a public transit station. The security officer had instructed a motorist who had parked his vehicle in a no parking area to leave the area and park elsewhere. Video evidence showed the security officer position himself a few feet behind the vehicle. The security officer claimed that there was ample room for the driver to pull forward. The driver placed the vehicle in reverse and slowly backed into the security officer making contact with the security officer. The security officer drew his firearm and as the vehicle was driving away firing several rounds into the rear tire of the vehicle.

**Answer:** \_\_\_\_\_

---

---

---

---

---

---

---

---

---

---

**Case Study #7**

You are a security officer working at a convenience store. You witness a patron get into an argument with the cashier over the return of some money. The patron starts picking items up off the counter and throwing them at the cashier. Then cashier also picks up items from the counter and throws them at the patron. You tell the patron to leave and the patron exits the store. On his way out of the store the patron states: "I'm going to go to my car and get my gun and blow your heads off, I'm going to kill all of you." You are positioned at the door of the store with the door to the store open where you can observe the patron in the parking lot. As the patron reaches his car you see the patron lift his untucked shirt and reach toward his waistband. Is the use of deadly force warranted?

**Answer:** \_\_\_\_\_

---

---

---

---

---

---

---

---

---

---

## SECTION 2

The following course information has been adopted from Chapter 3 of the Criminal Justice Standards & Training Commission's (CJSTC), Florida Basic Recruit Training Program: High Liability, Volume 2. The Florida Department of Agriculture and Consumer Services, Division of Licensing, has modified the information solely to identify its applicability to the Class "G" trainee and licensee and does not claim the rights to any of the information within Section Two of this manual. This information is also available electronically from the Florida Department of Law Enforcement's website at:

**UNIT 1: FIREARMS SAFETY****LESSON 1 | Firearms Safety Procedures**Firearms Training Required  
Material**OBJECTIVES**

- ❖ Identify the shooting hand.
- ❖ Identify the support hand.
- ❖ Identify the common cause of most firearm accidents.
- ❖ Identify the general rules of safety that should be applied to all firearms.
- ❖ Identify what safety rules to follow on the range.
- ❖ Identify the requirements in the Florida Statutes for storing a firearm.

**Section Vocabulary***shooting hand**support hand*

**LESSON GOAL:** At the end of this lesson, you should be able to comprehend and demonstrate the firearms safety procedures that must be followed when handling or using firearms.

When studying firearms, the terms *shooting hand* and *support hand* are used to describe the hand used to shoot the firearm and the hand that aids the other in shooting, respectively. Your support hand is the hand that assists the shooting hand.

Safety is the most important element of firearms training. Negligence is the most common cause of firearms accidents. No matter how proficient you become at marksmanship, you and those around you are not safe if you negligently handle or discharge a weapon. The highest standards of firearms safety are required at all times. As students, and later as Class “G” Statewide Firearm license holders (herein after referred to as *Class “G” licensees*), you will follow all firearms safety rules. Facilitators and instructors will enforce those rules any time firearms are present, issued, or handled.

Always refer to the manufacturer’s manual for safety recommendations.

**General Rules of Firearms Safety**

- ❖ Always treat every firearm as if it were loaded, whether you think it is or not.
- ❖ Each time you pick up, put down, or hand a firearm to another person, open the firearm’s action and physically and visually inspect it to make sure that it is not loaded. This is called a safety check.
 

**Safety Note:** Never rely on memory to decide if a firearm is unloaded. Open the action and physically and visually check every firearm you handle during this course. If you touch it, first open the action and check it.
- ❖ Always point the muzzle in a safe direction. If a weapon pointed in a safe direction fires, it causes no personal injury and minor, if any, property damage. The environment dictates what direction is safe. In a building, for instance, people may be above or below you.
 

**Safety Note:** A safe direction is generally muzzle pointed down at a 45-degree angle away from your body with your finger outside the trigger guard.
- ❖ Never point a firearm at anyone or anything that you do not intend to shoot.
- ❖ Keep your trigger finger off the trigger and against the frame when drawing the firearm from or returning it to your holster.
- ❖ Never leave a loaded firearm unattended.
- ❖ Clean the firearm each time it is fired, and fully inspect the firearm once a week. Safety check the firearm each time you use it.

**Safety Note:** Before cleaning or handling a firearm, make sure that it is unloaded and is pointed in a safe direction. Never clean a loaded firearm.

## Rules for Firearms Safety on the Range

Follow these safety rules while on the firing range:

1. Immediately obey all directions and commands from the range instructor.
2. Care for and respect all firearms.
3. Never abuse firearms.
4. Perform a safety check each time you are issued or return a firearm. Open the cylinder or action to make sure the firearm is unloaded and perform a physical/visual check.
5. If loose screws and/or loose sights are discovered, report this to the range instructor.
6. Before training, the range instructor will inspect all firearms for proper function.
7. Always keep the firearm secure and in its holster unless otherwise instructed.
8. Keep all safety/retention devices securely engaged on holstered firearms at all times.
9. Never unholster a firearm behind the firing line.
10. When carrying unholstered firearms to and from the range, keep the action of the firearms open.
  - a. Carry revolvers by the tops of their frames with your fingers through the cylinder opening and the muzzle pointed in a safe direction.
  - b. Carry pistols with their magazines removed, action open, and muzzle pointed in a safe direction (safety on, if applicable).
  - c. Carry shotguns and rifles with their muzzles pointing in a safe direction, actions open and with the safety on.
  - d. Keep your trigger finger off the trigger and against the frame when drawing the firearm from or returning it to your holster.
  - e. Never anticipate any command.
11. Load only on the range instructor's command.
12. Retrieve dropped ammunition, speed loaders, magazines or equipment only when the range instructor declares it safe to do so.

**Safety Note:** Perform unloading procedures even if the firearm is unloaded when the instructor issues the unload command.
13. When you are on the firing line, you may leave only at the instructor's command.
14. Always point unholstered firearms in a safe direction.
15. Stop firing immediately at the cease fire command.
16. Never handle firearms on the firing line while someone is down the range.
17. Dry fire on the firing line only under a range instructor's supervision.
18. Only fire approved ammunition.
19. Always wear ear and eye protection on or near the firing line.
20. Never talk on the firing line unless your instructor speaks to you or in an emergency.
21. No tobacco products are allowed on the firing line.
22. Never eat on the firing line.

23. Be courteous to fellow shooters.
24. When not training, watch other shooters and listen to your instructor.
25. If you drop a firearm, do not pick it up; notify your instructor immediately.
26. If a weapon fails to fire, keep it pointed in a safe direction and immediately attempt to clear the malfunction. If the attempt to clear the malfunction fails, notify your instructor by raising your support hand.
27. Immediately report all injuries to a range employee or range safety officer. Learn the location of the first aid kit on the range.

### **Storing Firearms Safely**

As Class “G” licensees, you are responsible for making sure your weapon is secure while you are off duty. Section 790.174, Florida Statutes, addresses requirements for storing firearms safely.

1. A person who stores or leaves, on a premises under his or her control, a loaded firearm, as defined in s. 790.001, and who knows or reasonably should know that a minor is likely to gain access to the firearm without the lawful permission of the minor’s parent or the person having charge of the minor, or without the supervision required by law, shall keep the firearm in a securely locked box or container or in a location which a reasonable person would believe to be secure or shall secure it with a trigger lock, except when the person is carrying the firearm on his or her body or within such close proximity thereto that he or she can retrieve and use it as easily and quickly as if he or she carried it on his or her body.
2. It is a misdemeanor of the second degree, punishable as provided in s. 775.082 or s. 775.083, if a person violates subsection (1) by failing to store or leave a firearm in the required manner and as a result thereof a minor gains access to the firearm, without the lawful permission of the minor’s parent or the person having charge of the minor, and possesses or exhibits it, without the supervision required by law:
  1. In a public place; or
  2. In a rude, careless, angry, or threatening manner is a violation of s. 790.10, Florida Statutes.

This subsection does not apply if the minor obtains the firearm as a result of an unlawful entry by any person.

As used in this act, the term “minor” means any person under the age of 16.

**UNIT 2: FIREARMS FAMILIARIZATION**Firearms Training Required  
Material**LESSON 1 | REVOLVER****OBJECTIVES**

- ❖ Identify revolver parts with the correct nomenclature.
- ❖ Describe the function of revolver parts.
- ❖ Identify the steps to follow to safely handle a revolver.

**LESSON GOAL:** At the end of this lesson, you will know the revolver parts with correct nomenclature, how the parts function, and the steps to safely handle a revolver.

These next sections cover the nomenclature of the four weapons used in this training: revolver, semiautomatic pistol, shotgun, and semiautomatic rifle/carbine. The section also covers how each of these weapons works, and how their parts interrelate. You will learn to fieldstrip the weapons correctly and reassemble them to their original operational status.

All firearms have many of the same types of parts to achieve the same function. It is important to learn the nomenclature of the four weapons and how their parts function together to make the weapons work. This knowledge allows safe weapons operation on the range and in the field. It also helps you to better communicate with the armorer and to testify in court in a clear and credible manner.

**Nomenclature of the Revolver**

Revolvers may operate differently based upon who manufactured them. Refer to the Double Action Revolver Nomenclature Diagram (Figure 2-2). Make sure you are familiar with the nomenclature, each part's location, and function for the revolver that you use.

Following is the nomenclature associated with a revolver, a description of the parts of a revolver, and their functions:

back strap — portion of the grip that is placed in the palm of the shooting hand  
barrel—provides a path for the fired bullet  
center pin—on a Smith & Wesson revolver, it is the spring-loaded part that holds the cylinder closed

crane—attaches the cylinder to the frame so the cylinder can swing in and out of the frame opening; Colt uses the term crane; Smith & Wesson uses the term yoke (internal part)

cylinder—houses the extractor rod and contains the chambers that hold the cartridges

cylinder release latch—disengages the cylinder from the frame

cylinder stop—locks the cylinder

extractor—star-shaped device attached to the extractor rod that fits inside the cylinder that the rounds rest on (internal part)

extractor rod—when depressed, it causes the extractor to push the cartridge from the cylinder

frame—internal structure that holds the parts of the revolver and provides a way of gripping the firearm

front sight—located on the end of the barrel near the muzzle; it is designed for the swift location of the target and for bringing the firearm into alignment for accuracy

grip—made of wood, plastic, or rubber; designed to allow the shooter to grip the firearm easily for control

hammer—when the trigger is pulled, this part falls forward to activate the primer

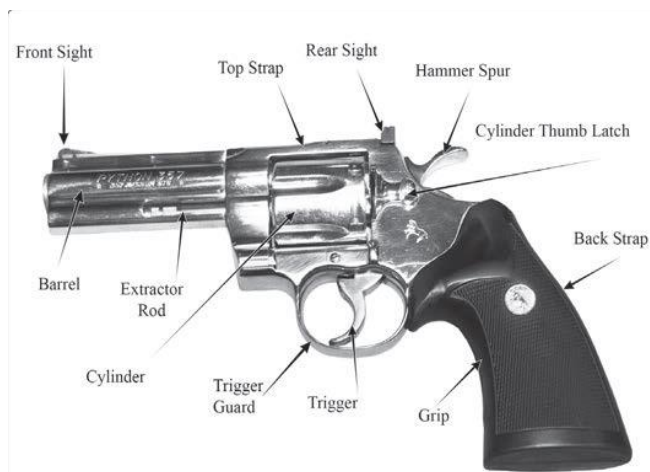

(Figure 2-2)  
Double Action Revolver



hammer nose—pin or firing pin—part of the hammer or frame that protrudes through the frame and strikes the primer (internal part)

hammer spur—part of the hammer used for cocking the weapon to single-action mode

hand—part of a revolver that turns the cylinder as the gun is cocked, thus aligning a cartridge with the hammer or firing pin (internal part)

rear sight—located on the rear of the frame; it can be adjustable or fixed

top strap—part of the frame that houses the rear sight, positioned over cylinder

trigger—activates the revolver's operation in both single and double action

trigger guard—part of the frame that protects the trigger

## How the Revolver Works

When the trigger is squeezed, the cylinder unlocks and rotates, placing a live cartridge in line with the firing pin. When the hammer falls, the hammer nose or firing pin strikes the primer and ignites the powder charge. The burning powder creates a gas, and pressure builds from the gas. This pressure sends the projectile (bullet) down and out of the barrel. The trigger releases forward, resetting the mechanism.

The direction of the cylinder rotation depends upon the manufacturer. A Smith & Wesson revolver rotates counterclockwise and the cylinder release latch pushes forward to release the cylinder. Ruger's revolver rotates counterclockwise; the cylinder release latch is depressed into the frame. A Colt revolver rotates clockwise. The cylinder release latch is pulled rearward to release the cylinder.

## Cycle of Operation

loading—placing live rounds into the open cylinder and closing the cylinder into the frame

locking—locking the cylinder into the frame

unlocking/feeding/locking—releasing the locked cylinder by squeezing the trigger so the cylinder can rotate and place a live round in front of the barrel in line with the firing pin; the cylinder then locks, allowing the firing pin to strike the live round that has been locked in place. The cylinder repeats this process with each pull of the trigger until all cartridges have been fired.

firing—ignition of the primer and firing the cartridge

extraction/ejecting—pushing or pulling the cylinder release latch; this rotates the cylinder out of the frame. Pushing the extractor rod ejects all cartridges.

## Handing the Revolver to Another Person

As Class “G” licensees, you will handle many firearms. In the course of your duties, you will hand over your firearm or a confiscated firearm. Safely handling the firearm is essential to protecting yourself and ensuring the safety of others.

To hand a revolver to another person, follow these steps:

1. With the barrel pointed in a safe direction, open the cylinder.
2. Visually and physically inspect the cylinder to make sure it is not loaded. If it is loaded, unload the revolver and ensure that all rounds have been removed.
3. With two or three fingers through the top strap, hand the revolver to the other person, grip first.

The person receiving the firearm should physically and visually check to make sure that the firearm is unloaded.

**UNIT 2: FIREARMS FAMILIARIZATION**Firearms Training Required  
Material**LESSON 2 | SEMIAUTOMATIC PISTOL****OBJECTIVES**

- ❖ Identify semiautomatic pistol parts with correct nomenclature.
- ❖ Describe the function of semiautomatic pistol parts.
- ❖ Identify the steps to safely handle a semiautomatic pistol.

**Section Vocabulary***double action only**double/single**single action*

accessory rail—provides space for lighting and sighting devices

back strap—portion of the grip that is placed in the palm of the shooting hand

frame/receiver—holds the internal parts, as well as the slide assembly, and provides a way to grip the pistol

front sight—located on the slide's front; used to bring the firearm into alignment for accuracy

front strap—portion of the grip that allows the fingers of the shooting hand to rest

grip panel—made of polymer designed to allow the shooter to easily grip and control the weapon

magazine catch—releases the magazine from the frame (magazine well)

magazine floor plate—base of the magazine

muzzle barrel—provides a path for the fired bullet and is chambered to hold the cartridge

rear sight—located on the rear of the slide that aligns with the front sight to bring the firearm into alignment for accuracy

slide—houses the firing pin, safety, drop safety, sights, and extractor

slide cover plate—allows access of the firing pin assembly

slide lock—device that allows quick and simple field stripping of the pistol

slide stop lever—device that locks the slide in the open position

thumb rest—place for the thumb to rest while gripping the pistol

trigger—activates the pistol's operation

trigger guard—part of the frame that protects the trigger

trigger safety—allows the trigger to move when pressed

**LESSON GOAL:** At the end of this lesson, you will know the semiautomatic pistol parts with correct nomenclature, how the parts function, and the steps to safely handle a semiautomatic pistol.

**Nomenclature of the Semiautomatic Pistol**

Semiautomatic pistols may operate differently based upon who manufactured them. Refer to the Semiautomatic Double Action Pistol Nomenclature Diagram (Figure 2-3a). Make sure you are familiar with the part names, locations, and functions of the pistol you use.

Following is the nomenclature associated with the semiautomatic pistol, a description of the parts of a semiautomatic pistol, and their functions:

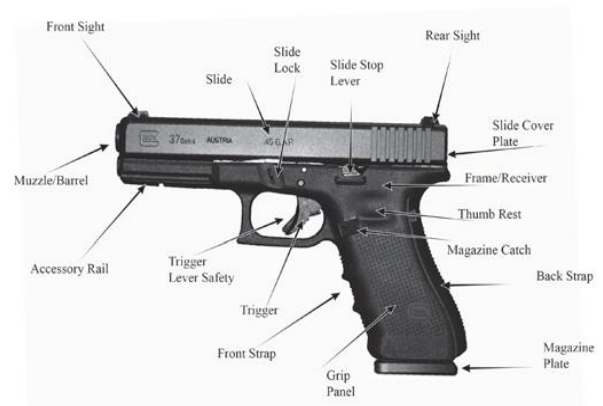

(Figure 2-3a) Semiautomatic Pistol

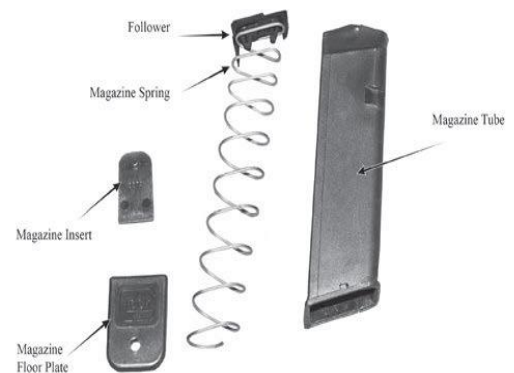

(Figure 2-3b) Semiautomatic pistol - magazine

The magazine holds the ammunition. It contains a spring and follower that pushes each round up to be stripped off by the forward movement of the slide. The follower also activates the slide stop. The floor/butt plate holds the magazine spring and follower in the magazine. You can remove it to clean inside the magazine. When reassembling the magazine, make sure to replace the spring and follower correctly. (Figure 2-3b)

The magazine consists of five main parts:

1. follower
2. spring
3. magazine insert
4. floor plate
5. magazine tube

Some additional parts of the semiautomatic pistol include the recoil guide, recoil spring, and slide. The recoil guide directs the recoil spring. It absorbs the recoil and returns the slide to the following position. The recoil spring pushes the slide forward.

## Types of Pistols

Pistols are categorized by their type of trigger mechanism. A *single-action* mechanism performs the single action of releasing the hammer or striker. Once the first round is fired the automatic movement of the slide resets the mechanism for each subsequent shot.

When a pistol is *double action only*, every round fires double action with the hammer at rest against the rear of the slide. Every time the trigger is pulled to the rear, it manually cocks and releases the hammer to fire the pistol. As the slide cycles and goes forward, the hammer safety follows, coming to rest against the rear of the slide. The hammer never stays cocked. The weapon's trigger pull is the same each time.

In a *double/single* pistol, the first round fires double action. (The trigger being pulled to the rear manually cocks the hammer and releases it.) The second and subsequent rounds fire single action as the hammer remains cocked each time the slide cycles. After firing is complete, the hammer remains cocked. Before holstering the weapon, it must be de-cocked using the de-cocking lever.

The Glock action is sometimes referred to as a "striker fire action." The Federal Bureau of Alcohol, Tobacco, and Firearms (ATF) classifies the Glock as a double action pistol. As the Glock trigger is pulled, the firing pin is pulled to the rear (first action) until released by the trigger bar (second action), which allows the firing pin to move forward and strike the primer.

Glock refers to their firearm as a "safe action pistol."

## How the Semiautomatic Pistol Works

A semiautomatic pistol functions by using the energy from the recoil of a single round of ammunition to extract and eject a fired cartridge from the pistol's chamber and load an unfired round from a magazine into the chamber for the next shot. As noted above, semiautomatic pistols may be double/single action or double action only.

As you draw the trigger fully to the rear in double action mode, the hammer moves back and then releases to strike the firing pin. Upon firing, the slide moves back, extracting and ejecting the spent cartridge case and pushing the hammer to the fully cocked position. As the slide moves to the rear, the recoil spring compresses. When all the energy has been used, the spring decompresses, pushing the slide forward. Then the slide returns forward, feeding the next cartridge from the magazine to the barrel chamber. For double action only pistols, this operation repeats each time. In double/single action pistols, the hammer remains cocked and the trigger is in the rear position, so subsequent shots fire in single-action mode. This sequence repeats until the last round fires. Then the magazine follower exerts upward pressure on the slide stop, causing it to engage and hold the slide in the open position

### **Cycle of Operation (open action)**

loading—seating a loaded magazine into the magazine well

feeding/chambering—moving the round from the magazine to the chamber by releasing the slide, picking up the round from the magazine and seating the round into the chamber

locking—the breech end of the barrel locks into the slide

firing—ignition of the primer and firing the cartridge

unlocking—unseating the breech end of the barrel from the slide

extraction—“pulling” the spent cartridge from the chamber

ejecting—“pushing” the spent cartridge out of the ejection port

cocking—returning the firing mechanism to the fire position

### **Performing a Function Check**

A function check ensures that the weapon functions properly. It is usually performed after field stripping or cleaning and reassembling the pistol. To perform a function check, follow these steps:

#### *Glock:*

1. Press the trigger and hold it to the rear.
2. Cycle the slide with the support hand and slowly release the pressure of the trigger until the trigger resets; you should hear a click and feel the reset on the trigger.

#### *Other types of semiautomatic pistols:*

1. Visually and physically check the firearm to make sure it is unloaded.
2. Operate the slide several times to ensure that it operates freely.
3. If the firearm has a magazine disconnect, follow the manufacturer’s instructions to perform a function check.
4. Put the manual de-cocking/safety lever in the off position.
5. Pull the trigger. The weapon should function properly.
6. If the weapon has an external hammer, then manually cock the hammer and pull the trigger. The weapon should function properly. If the weapon has a de-cocking lever, operate the slide and depress the lever. The pistol’s hammer should de-cock.
7. Lock the slide to the rear.
8. Insert an empty magazine into the magazine well until the magazine engages.
9. Depress the magazine release. The magazine should fall free.
10. Depress the slide release or pull the slide to the rear and then release. The slide should function properly.

## Handing the Semiautomatic Pistol to Another Person

To hand a semiautomatic pistol to another person, do the following:

1. Locate the manual safety on the semiautomatic pistol (if applicable). Put the safety in the on position.
2. Press the magazine release button and remove the magazine from the magazine well.
3. Secure the magazine.
4. Point the weapon in a safe direction, and pull the slide to the rear to extract and eject the live round from the chamber.
5. Lock the slide to the rear using the slide stop on the weapon's frame.
6. Visually and physically inspect the chamber and magazine well to make sure they are empty.
7. With the slide locked to the rear and the magazine well empty, hand the semiautomatic pistol to the other person, grip first. (Figure 2-4)



(Figure 2-4) Handing the Semiautomatic Pistol to Another Person

The person receiving the firearm should physically and visually check to make sure the firearm is unloaded.

**UNIT 2: FIREARMS FAMILIARIZATION****LESSON 3 | SHOTGUN**

**LESSON GOAL:** At the end of this lesson, you will know the shotgun parts with correct nomenclature, how the parts function, and the steps to safely handle a shotgun.

A shotgun is a smooth bore gun designed for firing at short distances. This weapon's general specifications are as follows:

gauge—12 gauge (ga) most common; chamber 2 3/4 or 3 inches

magazine tube capacity—see manufacturer's specifications

length—overall 38 inches with an 18-inch barrel (standard)

weight—see manufacturer's specifications

sights—rifle or bead

choke—full, modified, improved cylinder

stock—see manufacturer's specifications

barrel—18-, 20-, and 22-inch barrels most commonly used

safety—see manufacturer's specifications

**OBJECTIVES**

- ❖ Identify shotgun parts with correct nomenclature.
- ❖ Describe the function of shotgun parts.
- ❖ Identify the steps to safely handle the shotgun.

**Nomenclature of the Shotgun**

Make sure you are familiar with the part locations and functions for the shotgun you are using. Part names and locations, and some part designs, vary from model to model. Refer to the Shotgun Pump Action Nomenclature Diagram (Figure 2-5).

The following is nomenclature associated with a shotgun, a description of the parts of a shotgun, and their functions:

action/slide release—mechanical device that, when activated, releases the slide

barrel—long cylinder-shaped tube through which the projectile travels from the chamber

bolt—cylindrical steel part containing the firing pin and extractor, which closes the breech end of the barrel for firing

bolt carrier—flat steel part that fits onto the action bars and on which the bolt sits

ejection port—opening on the side or bottom of the receiver; spent casings are ejected from it and live rounds are loaded into this port

ejector—piece of spring steel mounted on the inside left of the receiver; when the action pulls a shell to the rear, it compresses and then releases the ejector as the bolt goes past it. A small extension stops the shell from going further and assists in ejecting the shell from the receiver.

extractor—metal hook-shaped part mounted on the bolt; the hook engages the rim of the cartridge so that when the action is brought to the rear, the extractor removes the shell from the chamber.

fore-end or slide—wooden or polymer grip near the magazine

front/bead sight or post—bead or raised post on the front of the barrel used to bring the firearm into alignment for accuracy

loading port—bottom opening on the receiver that live rounds are fed into or removed from the magazine tube



(Figure 2-5) Shotgun pump action nomenclature  
Position of parts may vary depending upon the make and model of the weapon.

magazine cap—located on the magazine tube's end and keeps the barrel in place

magazine tube—located under the barrel and holds rounds

muzzle—barrel's front end

rear sight—secondary aligning device located on the receiver or barrel that aligns with the front sight bead or post to bring the shotgun into alignment for accuracy

receiver—holds the trigger group and bolt assembly

safety—mechanical device that prevents a shooter from pulling the trigger and discharging the shotgun

shell carrier—slightly rounded steel part that blocks the loading port; catches rounds released from the magazine and raises them into alignment with the chamber

shell latches (stops)—two pieces of steel mounted on each side of the inside of the receiver at the magazine's rear; they help hold the cartridges in the magazine and release them one at a time when the action operates. They are also used to manually unload the shotgun.

stock—part of the weapon attached to the receiver; a shooter places the stock on his or her shoulder when firing. Nomenclature of the stock includes the following:

butt—rear area of the stock that the shooter mounts against the shoulder for firing; normally covered with a metal or plastic butt plate or a recoil pad

comb—stock's top edge where the shooter's cheek rests

grip—"small of the stock," just behind the receiver; the shooter uses the grip and his or her shooting hand for control when firing or carrying it

heel—top corner of the butt

recoil pad—a butt plate, usually rubber, that reduces the effect of the shotgun's recoil or "kick"

toe—the bottom part of the butt

trigger—when pulled, this releases the sear (a part that holds the hammer in the cocked position) and activates the firing pin

trigger guard—part of the frame that protects the trigger

## How the Shotgun Works

### Cycle of Operation (Pump Action Shotgun)

loading—placing live rounds in the magazine tube or open ejection port

chambering—removing a round from the magazine tube and placing it in the barrel's chamber by cycling the weapon, or after placing a round in the open ejection port, pushing the slide forward

locking—closing the action to a locked position by moving the fore-end forward until it stops

firing—discharging the weapon by depressing the trigger

unlocking—weapon unlocks when fired

extracting/ejecting—extractor's removal of the empty casing from the chamber and pushing the empty casing out of the weapon through the ejection port by manually cycling the slide/fore-end grip to the rear

### Performing a Function Check (Pump Action Shotgun)

1. With the safety in the on position and the shotgun pointed in a safe direction, cycle the action and leave it closed.
2. Depress the trigger; nothing should happen.
3. Release the trigger and move the safety to the off position. This means the trigger, sear, and hammer will work as they should.
4. Holding the trigger back, cycle the action of the shotgun. You should hear the bolt lock into position and nothing else.
5. Release the trigger. You should hear the disconnecter move into place. This tells you that the disconnecter is working.
6. Pull the trigger to the rear. You should hear the hammer fall and strike the firing pin.
7. Place the safety in the on position.
8. Open the action.

### Handing the Shotgun to another Person

*To hand a shotgun to another person, follow these steps:*

1. Place the safety in the on, or engaged, position.
2. Unload the shotgun.
3. Verify that no ammunition is in the magazine chamber and tube with a physical and visual check.
4. Make sure the fore-end is to the rear and the ejection port is open.
5. Hand the shotgun to the person in the port arms stance.

*To assume the port arms stance:*

- a. Hold the stock with your shooting hand and the fore-end with your support hand.
- b. Point the barrel in a safe direction.
- c. Put the safety in the on position, the fore-end to the rear, and the ejection port open, facing the person receiving the weapon.
- d. The person receiving the firearm should physically and visually check the firearm to make sure it is unloaded.



**UNIT 2: FIREARMS FAMILIARIZATION****LESSON 4| SEMIAUTOMATIC RIFLE/CARBINE****OBJECTIVES**

- ❖ Identify semiautomatic rifle/carbine parts with correct nomenclature.
- ❖ Describe the function of semiautomatic rifle/carbine parts.
- ❖ Identify the steps to safely handle the semiautomatic rifle/carbine.

**LESSON GOAL:** At the end of this lesson, you will know the semiautomatic rifle/carbine parts with correct nomenclature, how the parts function, and the steps to safely handle a semiautomatic rifle/carbine.

**Nomenclature of the Semiautomatic Rifle/Carbine (AR-15 style, gas operated system)**

Part names, locations and some part designs may vary depending on the specific make and model. Make sure you are familiar with the part names, locations, and functions for the weapon that you use. Refer to the Semiautomatic Rifle Nomenclature Diagram (Figure 2-6).

The following is nomenclature associated with the semiautomatic rifle/carbine, a description of the parts of a semiautomatic rifle/carbine, and their functions:

barrel—provides a path for the fired bullet; its chamber holds the cartridge

bolt—contains the firing pin, spring, and extractor (internal part)

bolt lock lever—holds the bolt to the rear when the charging handle is pulled to the rear and the lower portion is depressed; releases the bolt when the upper portion is depressed

buffer/buffer spring—enables the bolt to return after firing (internal part)

butt—the end of the stock

chamber—supports the cartridge at rest and during firing (internal part)

charging handle—enables manipulation of the bolt to chamber a round

ejection port—opening that permits the shell to exit the weapon (internal part)

ejector—expels the shell from the ejection port (internal part of the bolt)

extractor—grips and pulls the shell from the chamber

forestock/hand guard—used to support the rifle with the support hand; acts as a heat shield from the barrel

forward assist—a button assuring that the bolt is seated

lower receiver group—contains the magazine release, magazine well, trigger housing, and trigger components

magazine—contains ammunition ready to be chambered

magazine release—permits removal of the magazine from the firearm

magazine well—housing for the magazine (internal)



(Figure 2-6) Rifle/Carbine  
Position of parts may vary depending upon the make and model of the weapon.

muzzle flash suppressor—attachment on the barrel's forward end that reduces the flash as burning powder escapes when the bullet exits the barrel

safety—blocks the hammer from striking the firing pin; prevents firing (located on the left side of the weapon)

sights (front and rear)—used to align the firearm to the bullet's point of impact

slings—metal loops affixed to the rifle/carbine to which a carrying strap attaches

stock—part that enables shoulder support during firing

take down pins—enables separation of the upper receiver from the lower receiver and allows for field stripping and cleaning

trigger—enables the firearm to fire when pulled

trigger group—section consisting of the trigger, trigger springs, safety, and all firing mechanism parts

trigger guard—part of the frame that protects the trigger

upper receiver group—houses the bolt assembly group

### **How the Semiautomatic Rifle/Carbine Works**

A semiautomatic gas operated AR-15 style rifle functions by using the pressurized gas from a fired cartridge tapped from the barrel as the bullet moves past a gas port located under the rifle's front sight base. The gas rushes into the port and down a gas tube which extends into the AR-15's upper receiver. This forces the bolt assembly group rearward resulting in the extraction and ejection of a fired casing from the rifle's chamber. This action also re-cocks the hammer. The bolt assembly group is then forced forward by the buffer spring causing a live round to be picked up from the magazine and seated into the chamber for the next shot.

### **Cycle of Operation**

loading—seating a loaded magazine into the magazine well

feeding/chambering—moving the round from the magazine to the chamber by releasing the bolt, picking up the round from the magazine and seating the round into the chamber

locking—the face of the bolt locks with the breech end of the barrel

firing—ignition of the primer and firing the cartridge

unlocking—unseating the bolt from the breech end of the barrel

extracting—pulling the spent cartridge case from the chamber

ejecting—pushing the spent cartridge case out of the ejection port

cocking—returning the firing mechanism to the fire position

**Performing a Function Check**

1. Operate the bolt several times to make sure it moves freely.
2. Close the bolt and put the safety on.
3. Pull the trigger. The weapon should not work.
4. Move the safety to the fire position.
5. Pull the trigger to the rear, and hold it there. The hammer should fall as you pull the trigger.
6. Keeping the trigger to the rear, pull back the bolt. Allow the bolt to move slowly forward. You should hear a click as the hammer resets.
7. Release and pull the trigger again. The weapon should function properly.
8. Lock the bolt carrier assembly to the rear.
9. Insert an empty magazine into the magazine well until the magazine engages.
10. Depress the magazine release. The magazine should fall free.

**Handing the Semiautomatic Rifle/Carbine to another Person**

To hand a rifle/carbine to another person, follow these steps:

1. Ensure the safety is in the on, or engaged, position.
2. Remove the magazine.
3. Lock the bolt assembly group to the rear; physically and visually inspect the chamber to ensure it is unloaded.
4. Hand the semiautomatic rifle/carbine to the person with the muzzle pointed in a safe direction. The person receiving the firearm should physically and visually inspect the firearm to make sure it is not loaded.

## UNIT 3: AMMUNITION USE

Firearms Training Required  
Material

### LESSON 1| AMMUNITION IDENTIFICATION AND MAINTENANCE

**LESSON GOAL:** At the end of this lesson, you should be able to identify different types and calibers/gauges of ammunition and know how to inspect ammunition for defects and how to store ammunition properly.

#### Cartridge Parts and Types

Please refer to the cartridge diagrams below. They illustrate the basic parts of ammunition for a revolver, a pistol, a shotgun, and a rifle/carbine. The definitions for these parts can also be found in the Firearms Glossary.

case/casings—the metal or plastic container that holds all parts of a round of ammunition: primer, powder charge, and bullet

rim—the edge on the base of a cartridge case that stops the progress of the case into the chamber

crimp (shotgun only)—the part of the case mouth that bends inward to grip the bullet; with shotgun shells, the term applies to the closure at the case mouth.

headstamp—markings found on the head of ammunition that indicate caliber or gauge and identify manufacturer

shot (shotgun)—spherical pellets of various sizes, usually made of lead

primer—small, metal cup containing the detonating mixture used to ignite the propellant or powder charge

powder—propellant used in most firearms; produces a large volume of gas when ignited

#### OBJECTIVES

- ❖ Identify ammunition parts and nomenclature.
- ❖ Identify ammunition by appearance and caliber.
- ❖ Identify shotgun ammunition by appearance and gauge.
- ❖ Identify any abnormalities or defects on ammunition.
- ❖ Identify proper storage procedures for ammunition.
- ❖ Differentiate between duty life and shelf life.
- ❖ Properly store and handle ammunition.

#### Section Vocabulary

<i>birdshot</i>	<i>headstamp</i>
<i>bullet</i>	<i>powder</i>
<i>caliber</i>	<i>primer</i>
<i>case</i>	<i>rifled slug</i>
<i>crimp</i>	<i>rim</i>
<i>double-aught</i>	<i>round</i>
<i>buckshot</i>	<i>shelf life</i>
<i>(00 buckshot)</i>	<i>shot</i>
<i>duty life</i>	<i>wad</i>
<i>gauge</i>	

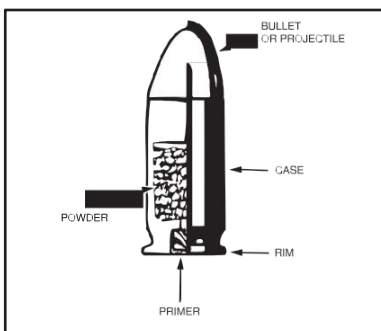

(Figure 3-1)  
Pistol Cartridge

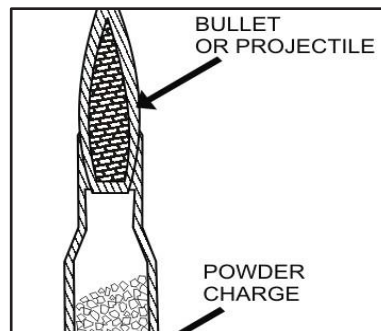

(Figure 3-2)  
Rifle Cartridge

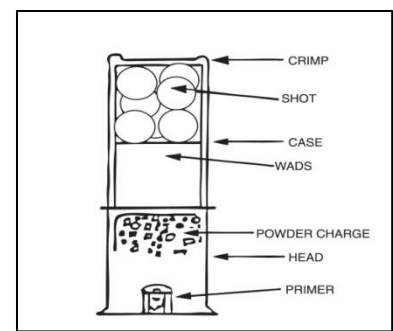

(Figure 3-3)  
Shotgun Cartridge

wad (shotgun)—the only part not found in any other centerfire cartridge; this is used to seal/confine gases; can be made of plastic or compressed cardboard

bullet—portion of the cartridge that becomes a projectile when in flight

round—complete ammunition cartridge that contains all parts of ammunition; a military term meaning one single cartridge

Ammunition can be identified by examining the caliber or gauge found on the cartridge's *headstamp*. **Caliber** is a measurement used to identify different cartridge (projectile) sizes. It is determined by measuring the diameter of the bore of the firearm. This helps identify the correct ammunition for a specific weapon. **Gauge** is a measurement of shotgun bores derived from the number of bore-sized balls of lead per pound. For example, 12 balls that fit the bore of a 12-gauge shotgun weigh one pound.

Law enforcement most often uses these caliber and gauge types:

- ❖ revolver—.38 Special, the .357 Magnum

**Note:** You can safely use .38 caliber ammunition in a .357 revolver. However, you cannot use .357 ammunition in a .38 caliber revolver. A .357 cartridge casing is longer than a .38 cartridge and so does not fit into the chamber of a .38 revolver.

- ❖ semiautomatic pistol—.40 caliber, .45 caliber, 9 mm, and 10 mm
- ❖ shotgun—12 gauge
- ❖ rifle/carbine—223 Remington, 9 mm, and 10 mm

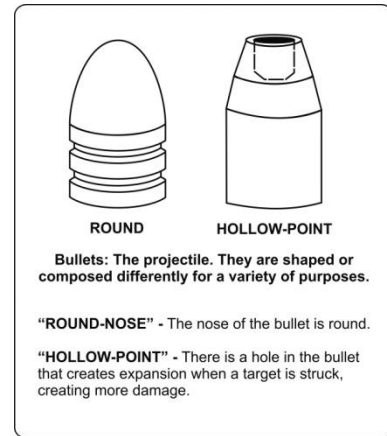

(Figure 3-4)  
Bullet (projectile)  
Design

Refer to the Bullet (Projectile) Design diagrams. Learn the definitions and ballistic characteristics of each ammunition type so that you can identify them:

blank round—a round designed for training or noise; the casing's cardboard material becomes a projectile when fired; the projectile cannot penetrate drywall or hollow core doors. However, it can penetrate soft body tissue. When fired at close range, it can cause serious injury or death. Do not discharge in the direction of others. Use extreme caution.

lead round nose—cartridge design that features a solid lead bullet with a round nose; this bullet has a medium velocity. By design, it easily penetrates interior walls or hollow core doors and then ricochets.

jacketed soft point—one-half to three-quarters of this lead bullet is jacketed with copper; the exposed lead on the flat nose allows for expansion upon impact. Usually of high velocity, this bullet is designed for antipersonnel. The round easily penetrates interior walls and solid doors.

hollowpoint—lead or copper-jacketed lead with a hollow cavity in the bullet's nose; as the bullet expands upon impact, it expends its kinetic energy. Since a hollowpoint expands quickly, it does not penetrate as deeply as a round-nose bullet. This design reduces ricochet. Usually of high velocity, it delivers maximum shock upon striking a surface of soft tissue.

full metal jacket—a round-nose lead bullet completely covered with a copper jacket; sometimes called ball ammunition, it is normally of medium to high velocity. Used extensively by the military, it has low expansion and high penetration capabilities. The chance for ricochet is high.

frangible—normally made of brass or copper dust held together with a resin material that disintegrates upon impact with steel or concrete; it can penetrate hollow core doors, drywall, or thin wood material.

armor piercing—made of solid carbon or tungsten steel coated with bright green Teflon; it has a considerably sharper point than most manufactured rounds. The round can pierce protective body armor or steel. In Florida, its use or possession is illegal for anyone but law enforcement.

tracer—full metal-jacketed bullet with incendiary material in the casing of its base; when fired, the round can be visually tracked by the burning material. The bullet tip is normally painted red or orange. Having the same velocity as a full metal-jacketed bullet, it is most often used by the military in fully automatic weapons.

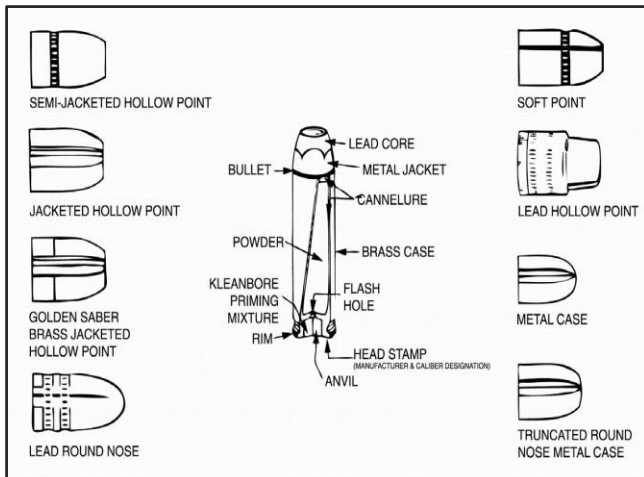

(Figure 3-5)  
Handgun bullet styles

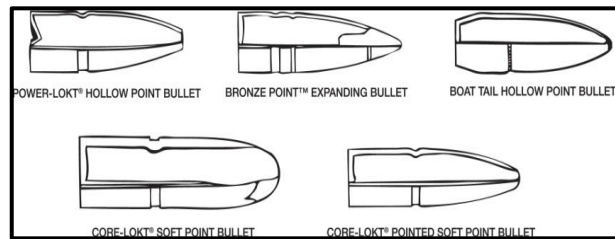

(Figure 3-6)  
Rifle bullet styles

## Shotgun Ammunition

**Birdshot** is normally used for bird hunting or practice; this shell has a load of small diameter lead or steel shot pellets. When fired at close range, these pellets can be dangerous and cause injury. Law enforcement uses birdshot for training purposes only.

**00 buckshot** (double-aught buckshot)—The standard 2 3/4-inch shell contains nine .33 caliber lead pellets. The three-inch magnum shell contains twelve .32 caliber pellets. The spread pattern from a 20-inch barrel is approximately one-inch spread per yard. For example, at 20 yards, the spread pattern equals 20 inches. Because of the spread pattern, Class “G” licensees must use extreme caution when shooting 00 buckshot in populated areas. They must be aware of what is around and behind the targeted area. Accurate maximum distance for law enforcement purposes is approximately 40 yards. The pellets penetrate solid wood doors, drywall, and wood walls at close range. The pellets can ricochet when they hit hard surfaces.

A **rifled slug** is a single, hollow lead bullet that weighs from 7/8 to 1 1/8 ounce. It is .72 caliber with an effective range of approximately 100 yards. The round penetrates most materials but not solid steel.

## Inspecting Ammunition for Possible Abnormalities or Defects

It is important to know how to inspect ammunition for functionality and dependability. Your ammunition may be the correct type, caliber, and gauge, but it must still be checked for damage or defects. This section covers the most common types of ammunition defects and how to inspect ammunition for those abnormalities or defects. When inspecting ammunition, these abnormalities and defects may be encountered:

scrape—indentation in the case that may weaken the case wall; a scrape makes a layer of the case wall metal look as if it has been scratched or torn away

dent—dimple or depression in the case; the case looks like someone struck it with a hard object, crushing part of it inward

corrosion—layering of the case with oxidation or foreign material, such as mold, fungi layers, congealed oil, and lubricants

puncture—actual tear, detachment, or rip that looks like an opening in the case body

Inspecting ammunition before loading is important. As you do so, identify and separate less than perfect rounds from service ammunition. Before heading out on duty, check your ammunition to make sure it operates properly.

1. Make sure that the casing is free of defects. Look and feel for scrapes, dents, corrosion, and punctures.
2. Determine that the projectile is firmly seated in the casing. Feel both ends of the ammunition to make sure the projectile is not loose.
3. Ensure that the primer is seated properly and free of indentations. Look at and feel the cartridge to see if the primer is flush with the rim.
4. Establish that the rim is free of defects. Look and feel for scrapes, dents, corrosion, and punctures.

## **Ammunition Storage**

Properly storing and handling your ammunition also helps prevent defects. When storing ammunition, following the manufacturer's recommendations is crucial. Respect the manufacturer's original design: Do not alter the ammunition. Environmental conditions affect the ammunition's shelf and duty life expectancy and may cause malfunctions when you use the cartridges. Keep your ammunition in a cool place where moisture is minimal. Do not use cartridges that have been water soaked as seeping water may affect the primers. Also, avoid keeping ammunition in locations where there is atmospheric heat, such as inside a closed vehicle, or where there is radiant heat (for example, inside a box in a sunny location). Follow your agency's standard operating procedure for storing ammunition.

*Duty life* is the recommended time (normally expressed in months) for which you can expect ammunition to be reliable when used on duty. Ammunition used on duty is exposed to environmental elements, such as heat and humidity, which cause it to deteriorate more quickly. Its duty life is shorter than its shelf life. It is recommended that ammunition be replaced annually.

*Shelf life* is the recommended time (normally expressed in years) for which you can expect ammunition to be reliable from manufacture time to issue time. Duty life is factored into shelf life, which also depends on care and protection of the ammunition. Therefore, it is important to write on the box the date you received and stored ammunition. That helps determine how long it stays on the shelf.

## **Handling Ammunition Safely**

Proper maintenance of ammunition involves any care that helps provide the most safety when using and inspecting ammunition. Improperly maintained ammunition may cause a weapon to fail to fire or function. In a self-defense situation, serious injury or death may result.

Use only factory-loaded ammunition from a reputable manufacturer. Do not drop or throw ammunition—it may discharge. Do not place ammunition in the radio holder of your patrol vehicle. Contact with an electrical impulse can cause ammunition to discharge.

Avoid using solvents and lubricants when handling ammunition. To prevent solvents on your hands from seeping into the primers, wash your hands before handling ammunition. Solvents and lubricants may cause a failure to fire malfunction.

Do not use reloaded cartridges "reloads" for duty ammunition. Reloads are cartridges that have been prepared using previously fired brass cases. They are not as reliable as new ammunition. Also, using reloaded ammunition may void the warranties of many firearms.

**UNIT 4: FUNDAMENTALS OF MARKSMANSHIP**Firearms Training Required  
Material**LESSON 1 | HANDGUN**

**LESSON GOAL:** At the end of this lesson, you will understand the fundamentals of marksmanship and the general principles of using a flashlight when shooting a handgun.

**Grip**

**One Hand** — Follow these steps to grip the handgun properly with one hand:

1. Place the handgun in your shooting hand so that its barrel points in the direction desired. Place the webbing of the shooting hand around the handgun's backstrap.
2. Center the weapon between your thumb and forefinger. It should fit directly into the V of the web of your hand between your thumb and forefinger. Your forearm, hand, and weapon should form a straight line.
3. Apply a firm, uniform grip to the firearm. Use the same firmness you would in a handshake. Gripping too tightly can cause the hand and arm to shake; muscle spasms may begin after a short time. Gripping too loosely does not give you the necessary control of the weapon or its recoil.
4. Rest the thumb of your shooting hand along the frame. Keep the trigger finger (index finger of the shooting hand) outside the trigger guard until on target and ready to fire.

**Two Hands** — The two-handed grip lets you steady your shooting hand with your support hand. It thereby provides maximum support while firing.

Follow these steps to grip the handgun properly with two hands:

1. Follow the steps for the one-handed grip.
2. With your thumb and index finger in proper grip positions along the frame, wrap the fingers of your support hand tightly around the fingers of your shooting hand.
3. Place your support hand's thumb on or just below the thumb of your shooting hand, holding the weapon firmly. Do not overlap your thumbs or place the thumb of your support hand over the back of, or in the web of, your shooting hand.

**OBJECTIVES**

- ❖ Acquire a proper grip with a handgun.
- ❖ Obtain sight alignment with a handgun.
- ❖ Obtain sight picture with a handgun.
- ❖ Pull/squeeze the trigger until the handgun discharges (trigger control).
- ❖ Release pressure on the trigger until the trigger reengages (trigger reset).
- ❖ Follow through after the cartridge is fired.
- ❖ Assume an appropriate shooting position with the handgun from behind cover.
- ❖ Identify shooting stances to use when shooting a handgun.
- ❖ Shoot a handgun while using a flashlight.
- ❖ Identify techniques for shooting a handgun while using a flashlight.

**Section Vocabulary***barricade position**breath control**follow-through**point shooting**respiratory pause**sight alignment**sight picture**stance**trigger control*



## Sight Alignment and Sight Picture

**Sight alignment** is the relationship of the front sight and rear sight with the shooter's eye(s). It occurs when the top of the front sight is level with the rear sight's top edge and centered in the rear sight aperture or notch. Keep your eye(s) centered behind the rear and front sights. This is the most important aspect of aiming.

For proper sight alignment:

1. Look along the top of the weapon's sight plane.
2. Center the top of the front sight on a line along the top of the rear sight.
3. Center the top of the front sight horizontally and vertically in the rear aperture or notch. (Figure 4-1)

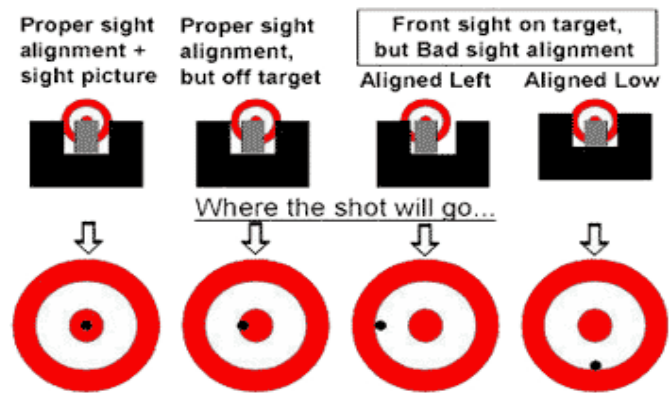

(Figure 4-1)  
Sight Alignment  
And Sight Picture

This is the most natural method of sight alignment. Your eye instinctively accomplishes this task with little training. This method also causes the least inconsistency from shot to shot.

**Sight picture** is the relationship between the eye, front sight, rear sight, and target. Follow these steps:

1. Look through the notch of the rear sight.
2. Align the top of the front sight with the top of the rear sight with equal space on each side.
3. Place the sights on the target.
4. Focus on the front sight. (The target will be blurry.)
5. Use your dominant eye to align sights.

Though it is recommended to keep both eyes open during firing, this practice may take time to get used to. Keeping both eyes open during firing has been known to improve the focus of your dominant eye and sight picture, as well as improve your accuracy, while providing increased peripheral vision.

The act of firing without disturbing sight alignment and the muzzle is a fundamental of marksmanship. Failure to control the trigger will result in improper sight alignment and motion in the muzzle when the hammer falls.

**Note:** Controlling the trigger is a mental process; pulling the trigger is a physical process.

## Breath Control

**Breath control** is important in the aiming process. If you breathe while trying to aim, the rise and fall of your chest moves the handgun vertically.

To hold your breath properly, inhale, exhale normally, and stop at the moment when you pause between breaths. The extended pause between breaths (*respiratory pause*) is the best time to fire the shot(s).

## Trigger Control and Follow-through

**Trigger control** results when the trigger finger pulls the trigger straight back with increasing yet constant and steady pressure until the firearm discharges. Trigger control, the most difficult handgun fundamental to master, often determines a shot's success.

To control the trigger properly,

1. The preferred method is to contact the trigger with your index finger. Be careful not to touch the firearm elsewhere with your trigger finger. After you place your trigger finger on the trigger, keep it there until you fire.
2. When controlling the trigger, make sure to move your trigger finger straight back. This will release the hammer and discharge the handgun.
3. Control the trigger reset after the weapon discharges. Release pressure on the trigger until the trigger reengages. Dry drills help you improve your ability to reset the trigger without disturbing sight alignment or your muzzle.

Improper trigger control causes more misses than any other action in the firing process. If you put even slightly off-center pressure on the trigger, the pressure can cause the firearm to move and disturb your sight alignment and muzzle. No one can hold a firearm completely motionless. Jerking the trigger disturbs your aim before the bullet leaves the barrel. Flinching—a human reflex caused by anticipating the firearm's recoil—also disturbs your aim, but a steady, controlled squeeze of the trigger will yield the best result.

Control the trigger during the shot while keeping the sight alignment and sight picture correct. When the sight picture settles, the pressure remains steady until the handgun fires. Focus on perfect aim as you apply trigger control. A firm handgrip is essential for good trigger control. Apply pressure on the trigger with the trigger finger only and without disturbing sight picture or sight alignment. Use the same grip for each shot. By placing your trigger finger in the same position on the trigger each time, you can move the trigger straight to the rear with the same results each time.

**Follow-through** involves maintaining sight alignment before, during, and after firing a round. You must maintain proper grip, stance, and finger placement on the trigger. You must also acquire sight picture, re-establishing it each time you fire a weapon. Do not try to force a handgun down at the time of discharge (anticipating recoil), but rather keep your body and weapon in a controlled position during discharge.

## Concentration

Concentration on the fundamentals is key to accurate and consistent shooting. For improved proficiency you should apply all the fundamentals simultaneously.

## Shooting Stances for a Handgun

**Stance** is the posture a shooter assumes while firing a shot. Proper stance is important when using firearms tactically or defensively. It gives the shooter more stability. From a steady and efficient shooting stance or stable shooting position, a shooter has the ability to move and engage targets properly.

A handgun can be fired from a number of stances: Isosceles, Weaver, Modified Weaver, hip, and tactical ready, as well as two-handed high point, barricade (standing and kneeling), and prone.

The Isosceles stance most closely represents the instinctive response to a threat. This stance minimizes the exposed areas of the body not covered by armor.

## Standing Position

*To shoot a handgun from the standing position:*

1. Stand with your feet approximately shoulder-width apart.
2. Keep your weight on the balls your feet.
3. Bend your knees slightly so you can move in any direction.
4. Move the foot on your weapon (shooting) side back slightly.
5. Square your head and shoulders to the target. Keep your back straight and head erect (unless you are using the Modified Weaver stance.)
6. Draw your weapon, raising it to eye level. Do not bend your head down to the weapon's level.
7. After you fire the weapon, continue to cover your target and scan for additional threats.

## Kneeling Position

*To fire a handgun from the kneeling position:*

1. Begin in the standing position.
2. Draw your weapon and step forward with your opposite foot.
3. Drop your shooting side knee to the ground, keeping the muzzle of your weapon pointed downrange. Keep your finger off the trigger.
4. As you drop your knee, bring your arms up, raising your weapon to eye level. Keep your head erect and your back straight.

From the waist up, the kneeling and standing positions do not differ. From the waist down, the kneeling position differs only in that your shooting side knee is on the ground and your support knee is up.

## Isosceles Stance

*To shoot a handgun from the isosceles shooting stance:*

1. Stand with your feet approximately shoulder-width apart. Keep your weight on the balls of your feet.
2. Bend your knees slightly to allow for movement.
3. Stand with your head and shoulders square to the target, body weight forward.
4. Lock your arms straight out in front, and bring the handgun to eye level. (Figure 4-2)



(Figure 4-2)  
*Isosceles Stance*

## Weaver Stance

*To fire the handgun from the Weaver stance:*

1. Stand at a 45-degree angle to the target, with your feet shoulder-width apart. Your weapon-side foot is to the rear.
2. Bend your knees slightly so your weight is on the balls of your feet. Keep your shoulders at a 45-degree angle to the target.
3. The weapon arm should be almost fully extended while your support arm is bent at the elbow. The elbows should be fairly close together not allowing them to flare out.
4. Push forward with your shooting hand and pull back with your support hand to create isometric tension.
5. Bring your weapon to eye level and keep your head erect. (Figure 4-3)



(Figure 4-3)  
Weaver Stance

## Modified Weaver Stance

The Modified Weaver Stance is similar to the Weaver Stance except the weapon arm is locked out straight. Other elements such as foot position may be modified because of a person's physical characteristics.

## Hip Shooting Stance

When you are within arm's reach (three to four feet away) of a subject, use the hip shooting stance. If you extend your arms to prepare to shoot your firearm, the subject would be close enough to grab your firearm or knock your hand and firearm to the side.

*To fire the handgun from a hip shooting stance, you have two options:*

*Option 1* — Shoot your handgun from the one-handed hip stance:

1. Assume the interview stance:
  - a. Stand with head, hips and feet aligned.
  - b. Stand with your feet approximately shoulder-width apart with knees slightly bent.
  - c. Angle your body to the subject with the weapon side away.
  - d. Keep your hands above your waist.
2. Draw your firearm.
3. Place the elbow of your weapon arm against the side of your body above the holster.
4. Point your forearm, hand, and firearm against the side of your body above the holster.
5. Put your support hand in a defensive position in front of your body. Keep it close to your chest to guard against attack, should you not draw your firearm quickly enough.

Option 2 (less preferable than Option 1) — Shoot your handgun from the two-handed hip stance:

1. Assume the interview stance.
2. Draw the weapon and keep your weapon-side elbow at a 90-degree angle (in an L shape). Keep your elbow against the body, slightly above the holster.
  - a. Keep your forearm and wrist and the barrel of your handgun parallel to the ground and pointed at the subject.
  - b. Grip the handgun a little more tightly than normal. This helps you keep your wrist straight and makes it more difficult for a subject to take your weapon.
3. Bring your support and shooting hands together in a normal two-handed grip.
  - a. Hold your weapon at waist level and both elbows tightly against your body above your gun belt.
  - b. Keep your forearm, hand, and weapon horizontal to the ground.
4. With both eyes open and looking at the subject, eye and hand coordination normally adjusts the weapon to the proper aim.

### **Tactical Ready Stance**

At times, you must cover a subject who is ready to take aggressive and perhaps deadly action. In the tactical ready stance, you can see a subject's hands. To take the tactical ready stance, you should assume the standing position described earlier, and then, lock your arms below your line of sight. In this stance, you will be able to observe the subject's hands/waistline.

The tactical ready stance may also be assumed by bending your elbows while pulling the handgun straight back and holding it close to your body. In this position you should maintain a proper grip while pointing the firearm in a safe direction or towards the threat. This variation of tactical ready stance is most commonly used in close-quarter situations or when the location of the threat is not immediately known.

### **Two-Handed, High Point Position**

In the two-handed, high point position, you are in the standing or kneeling firing position with your sights on the target.

### **Barricade Position**

A *barricade position* is a position behind cover.

*To fire the handgun from the standing barricade position:*

1. Start away from the barricade's outside edge.
2. Upon target stimulus or command, draw your firearm and move to cover.
3. Outstretch and lock your arms.
4. Assume a stable standing position.
5. Lean to your weapon side.
  - a. Expose the necessary portion of your shoulder and head.
  - b. Keep your firearm's muzzle away from and behind the barricade.
  - c. Do not let your firearm or hands rest on or touch the barricade. Keep them behind the lateral line of the barricade.

*To fire the handgun from the kneeling barricade position:*

1. Start away from the barricade's outside edge.
2. Upon target stimulus or command, draw your firearm and move to cover.
3. Point your firearm downrange, and keep your finger off the trigger.
4. Assume a stable kneeling position behind cover.
5. Lean to your weapon side.
  - a. Expose the necessary portion of your shoulder and head.
  - b. Keep your firearm's muzzle away from and behind the barricade.
  - c. Do not let your firearm or hands rest on or touch the barricade. Keep them behind the lateral line of the barricade.

### **Prone Position**

*To fire a handgun from the prone position:*

1. Kneel on both knees.
2. Draw the firearm and point it toward the target.
3. Lie on your stomach, face down, using your support hand for stability.
4. Assume a two-handed grip.

*To return to a standing position from a prone position:*

1. Keeping the firearm pointed in a safe position, use your support hand to rise to a kneeling position.
2. Return the firearm to the holster.
3. Safely stand.

### **One Handed Shooting:**

One handed shooting capabilities are a necessity. An officer's support hand or shooting hand may be incapacitated or limited when shooting from cover or concealment. Also, an officer will need this capability when handling a radio, checking a downed officer, opening a door, moving a blocking object, maneuvering a flashlight, etc.



(Figure 4-4)  
Strong Hand (R)

### **Strong Hand**

1. Strong foot forward: With weight shifted forward to reduce rocking backwards.
2. Shoulder, elbow, and wrist locked: This will aid in absorbing recoil.
3. Handgun canted at a 45 degree angle: This aids in sight alignment and aligns bones in the hand wrist and arm more naturally.
4. Support hand at center of chest: Avoid flailing hands and inadvertently "flagging" your own hand.
5. Transition to Weak/Strong hand at the High Ready Position
6. When transitioning the handgun from strong hand to your weak hand, ensure a high firm grip is established within your "work space" at the high ready position before pressing out on target. The negative effects of a poor grip are magnified in one handed shooting.

## Support Hand

1. Support foot forward: With weight shifted forward to reduce rocking backwards.
2. Shoulder, elbow, and wrist locked: This will aid in absorbing recoil.
3. Handgun canted at a 45 degree angle: This aids in sight alignment and aligns bones in the hand wrist and arm more naturally.
4. Support hand at center of chest: Avoid flailing hands and inadvertently “flagging” your own hand.



(Figure 4-5)  
Support Hand (L)

## General Flashlight Principles

The flashlight’s main function is illumination. This includes illumination for movement, navigation, and searching, as well as for identification and engagement of a threat. The flashlight may also be used to control someone if the light is bright enough. If you see an unknown person or a suspect approaching you, the light may disorient them. Design and ergonomics are critical to its proper and safe use. Firearm and hand sizes are two important factors in choosing an appropriate flashlight.

Generally, using a flashlight lets you make a smooth transition from search to firing mode. The relationship between the flashlight and the bore of the firearm may offer some recoil control so you can place shots efficiently. In reduced light, you can execute all the fundamentals you practiced. Always positively identify a threat before using deadly force.

Varying amounts of light in the confrontation area can work for or against you. When you move quickly from a lighted area to a reduced-light area, your visual acuity may be adversely affected for a period of time. When you move from a dark area to a lighted area, your silhouette may present you as a target.

Whenever possible, consider the options of illumination for movement, navigation, searching, and to identify and control suspects.

## Types of Flashlight Grips

- ❖ *“Watchman” grip* — The flashlight is held in the support hand with the illuminating end projecting from the index finger side of the hand. The thumb controls the on/off switch with a side-mounted switch near the front of the flashlight; the little or ring finger controls it with a side-mounted switch near the back of the flashlight.
- ❖ *“Law enforcement” or “tactical” grip* — The flashlight is held in the support hand with the illuminating end projecting from the little finger on the side of the hand. The thumb controls a rear-mounted switch; the index finger controls a side-mounted switch near the back of the flashlight; the little or ring finger controls a side-mounted switch near the back of the flashlight.
- ❖ *“Syringe” grip*—This grip is used with a small (4–6 inch) flashlight with a rear switch and a ring around the grip to give the index and middle fingers a hold. The flashlight is held in the support hand between the index and middle fingers. The switch is pulled back against the base of the hand or the knuckles of the shooting hand, depending on the technique used.

## Flashlight: Firearm Techniques

Firing a handgun at night hinders sight alignment (if the weapon has no night sights), the ability to obtain a sight picture, and the ability to identify threats or targets.

You must be able to identify a target or threat before engaging it with your handgun. Ideally, you should fire in reduced light (at night) only at close proximity because of the risk involved in identifying targets and threats. Focus on your weapon's front sight if you can see it. If you cannot, you must use the point shooting technique. **Point shooting** is the technique used when you cannot use the sights on your weapon or you have no time to align the sight properly. The handgun becomes an extension of your arm and hand. You use this "extension" to point to the target or threat and fire. Most flashlight-assisted shooting requires point shooting skills because point shooting can be very effective when the target is in silhouette. Also, flashlight-assisted conditions may alter how you see or use your sights. Again, you should use this method only if you are close to the target or threat. At more than seven yards, seek cover, and evaluate your options.

The following are techniques for shooting a handgun while using a flashlight.

### Ayoob Technique

This technique is thumb-to-thumb; it uses the "watchman" grip. It provides some support for firearm control and good illumination in relationship to the weapon.

To use this handgun/flashlight method, you should hold the handgun in your shooting hand and the flashlight in your support hand. Then, you should hold your hands out in front of you with your arms extended and hands pressed together at your thumbs.



(Figure 4-6)  
Ayoob technique

The light and handgun are side by side, so the light beam and handgun are parallel and point to the same place. You can quickly assume this position and easily identify a target. This method also helps illuminate the handgun sight. (Figure 4-6)



### Harries Technique

To perform the Harries technique, you should hold the flashlight in your support hand and the handgun in your shooting hand. Then, put the backs of your hands together. With your hands braced together, you have more control over the handgun. (Figure 4-7)

It is important to remember that using a flashlight at any time will give away your position. Also, the Harries technique is not a natural position to take, and requires practice. The key to the Harries method is properly using the law enforcement or tactical grip. This method illuminates the sights fairly well.

(Figure 4-7)  
Harries technique



## UNIT 4: FUNDAMENTALS OF MARKSMANSHIP

### LESSON 2 | SHOTGUN

**LESSON GOAL:** At the end of this lesson, you will understand the fundamentals of marksmanship when shooting a shotgun.

Class “G” licensees can improve their proficiency with a shotgun by applying the fundamentals of marksmanship which include grip, stance, sight alignment, sight picture, trigger control, follow-through, breath control, and concentration.

#### Shooting Stances for the Shotgun

This section teaches you to fire a shotgun from the standing, kneeling, low ready, and barricade positions.

##### Standing Position

*To shoot a shotgun from the standing position, you should follow these steps:*

1. Stand with your feet approximately shoulder-width apart and keep your weight on the balls of your feet.
2. Place your weapon-side foot slightly behind your support foot or stand with your head and shoulders square to the target, body weight forward. Keep your weight slightly forward on the balls of your feet. Bend your knees slightly to allow for movement.
3. With your shooting hand, grip the stock with your trigger finger alongside the receiver, and grip the fore-end with your support hand.
4. Shoulder the shotgun by placing the top of the stock between the shoulder and the collar bone so that your cheek naturally touches the comb of the stock.
5. To maintain proper sight alignment, press your cheek firmly against the comb of the stock.

##### Kneeling Position

To assume the kneeling position, keeping the firearm pointed in a safe direction, you should perform the following steps:

1. Kneel on your strong knee.
2. Extend your support leg toward the target with your foot flat on the ground.
3. Keep your ankle straight and the toe of your shoe in contact with the ground, curled forward by your body weight.
4. Hold the shotgun as you do in the standing position.

#### OBJECTIVES

- ❖ Identify shooting stances to use when shooting a shotgun.
- ❖ Assume an appropriate shooting stance with the shotgun from behind cover.
- ❖ Obtain sight alignment using a shotgun.
- ❖ Obtain sight picture with a shotgun.
- ❖ Pull/squeeze the trigger until the shotgun discharges (trigger control).
- ❖ Release pressure on the trigger until the trigger reengages (trigger reset).
- ❖ Follow through after the shell is fired.

## Low Ready Position

The low ready position is a position of readiness that allows the Class “G” licensee to immediately begin firing the shotgun or to take appropriate action and is used in the standing or kneeling positions.

To assume a low ready position, hold the shotgun’s butt in the curve of your shoulder and point the barrel toward the ground at an angle of approximately 45 degrees. This helps you use your peripheral vision and quickly react to a threat. Keep the muzzle of the gun pointed up and in a safe direction.

You will prepare to get into the low ready standing or kneeling positions from the port arms stance with your weapon across your chest—muzzle pointed in a safe direction, a stance normally used when you move from one safe position to another.

## Barricade Position

*To assume the barricade position, you would follow these steps:*

1. Stand in the open, next to the barricade, with your shotgun in a ready position.
2. Upon target stimulus/command, step behind the barricade and assume a standing or kneeling position.
3. Remove the safety and fire the prescribed number of rounds.

Do not let your weapon touch the barricade’s surface. The barricade is cover, not a resting place.

Stand or kneel a safe distance away from the barricade and use the roll-out technique to gain maximum protection from behind cover. Positioning your weapon-side leg to the rear makes you a smaller, harder- to-hit target for the aggressor.

## Shouldering the Shotgun

When shouldering a shotgun, your support elbow will be bent and your shooting-side elbow will be raised to create a pocket. You must grip the shotgun and place the recoil pad firmly into your shoulder pocket. Properly placing the recoil pad reduces the effect of recoil, helps steady the shotgun, and prevents the shotgun recoil pad from slipping.

*To properly shoulder the shotgun, do the following:*

1. Hold the stock just behind the trigger guard with your shooting hand by placing your thumb on top of the stock and wrapping your middle, ring, and pinky fingers on the bottom of the stock just behind the trigger guard.
2. Place your trigger finger on the receiver just above the trigger guard.
3. With your support hand, grasp the fore-end from underneath with your thumb on one side and remaining fingers on the other side.
4. Raise the shotgun and place the recoil pad into your shooting shoulder pocket. To seat the shotgun in your shoulder, pull back with your shooting hand.

## Cheek Weld

The cheek weld provides firm contact between your cheek and the comb of the stock. To form a cheek weld, raise the stock to your cheek; do not lower your cheek to the stock. Tightly hold the flesh against the cheekbone so it acts as a buffer. The firm contact between the head, hand, and shotgun enables your head and weapon to recoil as one unit. This aids in rapid recovery between rounds. The cheek weld lets you maintain the same distance behind the receiver, further assisting in correct sight alignment.

## Sight Alignment and Sight Picture

Sight alignment is the relationship of the front sight and rear sight with the shooter's eye. It occurs when the top of the front sight is level with the rear sight's top edge and centered in the rear sight. Keep your eye centered behind the rear and front sights.

Modern shotguns use two types of sighting systems: rifle sights and bead sights. Rifle-sighted shotguns have a front and rear sight. To use these sights properly, you must align the front sight with the rear sight. Bead-sighted shotguns have no rear sight. You must focus on the bead, and the barrel should not be visible. Sight picture is the relationship between the eye, front sight, rear sight, and target. Follow these steps:

1. Align the top of the front sight with the top of the rear sight with equal space on each side.
2. Place the sights on the target.
3. Focus on the front sight. (The target will be slightly blurry.)
4. Use your dominant eye to align sights. This may be altered if you are cross-eye dominant.
5. For bead sights, align your eye with the top of the receiver. Locate and focus on the bead, placing it on the center mass of the target.

## Breath Control

Breath control is important in the aiming process. If you breathe while trying to aim, the rise and fall of your chest moves the shotgun vertically.

To hold your breath properly, inhale, exhale normally, and stop at the moment when you pause between breaths. The extended pause between breaths (respiratory pause) is the optimum time to fire the shot(s).

## Trigger Control and Follow-through

Trigger control is the steady pressure applied directly to the rear until the hammer falls. The trigger of a shotgun is called a single-action trigger because the hammer is cocked each time the weapon is cycled. The trigger moves only a short distance before the sear trips and the hammer releases. The pressure needed to trip the sear is between four and eight pounds. Control the trigger until the shotgun discharges.

As the weapon cycles, you must allow the trigger to return to its forward position (reset). Failure to do so prevents the weapon from firing until you release and control the trigger again.

Proper follow-through involves maintaining sight alignment before, during, and after firing a round. You must maintain proper grip, stance, and finger placement on the trigger. You must also acquire a sight picture each time you fire the shotgun.

After firing a pump shotgun, you must bring the slide to the rear to extract the spent casing and return it to the forward position to chamber a new round.

## Concentration

Concentration on the fundamentals is key to accurate and consistent shooting. For improved proficiency you should apply all the fundamentals simultaneously.

## UNIT 4: FUNDAMENTALS OF MARKSMANSHIP

### LESSON 3 | SEMIAUTOMATIC RIFLE/CARBINE

**LESSON GOAL:** At the end of this lesson, you will understand the fundamentals of marksmanship when shooting a semiautomatic rifle/carbine.

Accurately shooting a rifle/carbine requires learning the fundamentals of marksmanship. These fundamentals include grip, stance, sight alignment, sight picture, trigger control, follow-through, breath control, and concentration.

#### Shooting Stances for Semiautomatic Rifle/Carbine

Semiautomatic rifles/carbines are fired from several positions: standing, kneeling, low kneeling, low ready, barricade, and prone.

##### Standing Position

*To shoot a semiautomatic rifle/carbine from the standing position:*

1. Stand with your feet approximately shoulder-width apart.
2. Keep your weight on the balls of your feet.
3. Bend your knees slightly so you can move in any direction.
4. Move your weapon-side foot back slightly, or stand with your head and shoulders square to the target, body weight forward.
5. With your shooting hand, grip the pistol grip with your trigger finger alongside the receiver.
6. Place the rifle/carbine butt high against your shoulders so that its sights are at eye level.
7. Place your support hand under the front of the stock/fore-end in a position that best helps you support and steady the rifle/carbine.
8. Lean slightly forward from the waist.
9. Place the butt of the stock between the shoulder and the collar bone so that your cheek naturally touches the top of the stock.

#### OBJECTIVES

- ❖ Acquire the proper grip with the semiautomatic rifle/carbine.
- ❖ Identify shooting stances to use when shooting a semiautomatic rifle/carbine.
- ❖ Assume an appropriate shooting stance with the semiautomatic rifle/carbine from behind cover.
- ❖ Shoulder the semiautomatic rifle/carbine.
- ❖ Obtain the cheek weld with the semiautomatic rifle/carbine.
- ❖ Obtain sight alignment with the semiautomatic rifle/carbine.
- ❖ Obtain sight picture with the semiautomatic rifle/carbine.
- ❖ Control the trigger until the semiautomatic rifle/carbine discharges.
- ❖ Release pressure on the trigger until the trigger resets.
- ❖ Follow through after the cartridge is fired.

**Kneeling Position**

*To shoot a semiautomatic rifle/carbine from the kneeling position, point the firearm in a safe direction and follow these steps:*

1. Kneel on your strong knee.
  - a. Keep the rifle's muzzle pointed toward the target.
  - b. Keep your finger off the trigger.
2. Extend your support leg toward the target with your foot flat on the ground.
3. Hold the rifle as you do in the standing position.

*To assume the low kneeling position:*

1. From the kneeling position, lower your weight onto your weapon-side leg.
2. Turn down your ankle.
3. Sit on the inside of your ankle. (Do not sit back too far; doing so causes poor balance.)
4. Hold the semiautomatic rifle/carbine as you do in the standing position.

*For all these positions, you should perform the following:*

1. Extend your support leg toward the target with your foot flat on the ground.
2. For maximum support, point your toes toward the target.
3. To prevent side movement, turn your support toes slightly inward by pivoting on your heel. When in position, you may push your support foot forward or pull it back slightly to lower or raise the muzzle.
4. Position the lower part of your support leg to provide maximum support for controlling the semiautomatic rifle/carbine. From a front view, the lower support leg appears nearly vertical. In this position, your support leg supports your body weight.
5. Place the back of the triceps of your support arm against the forward part of your knee.
6. Do not rest your elbow on your knee.

**Low Ready Position**

Use the low ready position only in the standing or kneeling positions. It is a position of readiness to begin firing the semiautomatic rifle/carbine or take appropriate action.

1. Hold the semiautomatic rifle/carbine's butt in your shoulder pocket.
2. Point the barrel at an angle of approximately 45 degrees with the ground. This helps you use your peripheral vision and quickly react to a threat.

You may also begin from the port arms position, normally used when moving from one safe position to another. Hold your weapon across your chest. Keep the muzzle pointed up in a safe direction.

**Prone Position**

*To shoot a semiautomatic rifle/carbine from the prone position:*

1. Stand facing the target, and place your support hand on the stock/pistol grip in front of the trigger guard.
2. Grasp the grip portion of the stock/pistol with your shooting hand.
3. Spread your feet, shifting your weight slightly to the rear.
4. Kneel on both knees.
5. Lean forward and use your support hand to ease your body to the ground.
6. Place your support elbow on the ground.

7. Gripping the stock/pistol grip with your shooting hand, place the semiautomatic rifle/carbine's butt into your shooting shoulder pocket.
8. Grasp the small of the stock/pistol grip with your shooting hand.
9. Lower your weapon-side elbow to the ground so that your shoulders are approximately level.
10. Place your cheek on the stock in a position where you can obtain proper sight alignment.
11. Do not rest the magazine on your arm or let it touch the ground.
12. Position your body behind the rifle to absorb recoil.

The prone position is steadier than standing and kneeling positions, easier to assume, and presents a lower profile. You can easily adapt it to the use of cover and support.

### **Barricade Position**

To assume the barricade position, you should stand in the open, next to the barricade, with your rifle/carbine in a ready position. Upon target stimulus/command, you should step back behind the barricade and assume a standing or kneeling position. Finally, remove the safety and fire the prescribed number of rounds.

Do not let your weapon touch the barricade's surface. The barricade is cover, not a resting place.

Stand or kneel a safe distance away from the barricade, and use the roll-out technique to gain maximum protection from behind cover. Positioning your weapon-side leg to the rear makes you a smaller, harder-to-hit target for the aggressor.

### **Shouldering the Semiautomatic Rifle/Carbine**

To shoulder the semiautomatic rifle/carbine, you must place the rifle butt firmly into your shoulder pocket. Properly placing the butt reduces the effect of recoil, helps steady the rifle, and prevents the rifle butt from slipping into the shoulder.

*To properly shoulder the rifle, do the following:*

1. Hold the stock just behind the trigger guard with your shooting hand by placing your thumb on top of the stock and wrapping your middle, ring, and pinky fingers on the bottom of the stock just behind the trigger guard.
2. Place your trigger finger on the outside of the stock just above the trigger guard.
3. With your support hand, grasp the forward portion of the stock from underneath with your thumb on one side and remaining fingers on the other side.
4. Raise the rifle and place the butt of the stock into your shooting shoulder pocket. Your support elbow will be bent and your shooting-side elbow will be raised to create a pocket. To seat the rifle in your shoulder, pull back with your shooting hand.

### **Cheek Weld**

The cheek weld provides firm contact between your cheek and the stock. To form a cheek weld, place your cheek firmly on the stock. The firm contact between your cheek and rifle enables your head and weapon to recoil as one unit. This aids in rapid recovery between rounds.

## **Sight Alignment and Sight Picture**

Sight alignment is the relationship of the front and rear sights on a weapon. Sight picture is the relationship between the eye, front sight, rear sight, and the target.

*For proper sight alignment and sight picture, you may try the following options:*

1. Look through the rear sight aperture (hole or peep).
2. Align the top of the front sight in the center of the rear sight aperture.
3. Use your dominant eye to focus on the front sight. This may be altered if you are cross-eyed dominant.
4. Align the sights on the center mass of the target (the target will be blurry).

## **Breath Control**

Breath control is important in the aiming process. If you breathe while trying to aim, the rise and fall of your chest moves the semiautomatic rifle/carbine vertically.

To hold your breath properly, inhale, exhale normally, and stop at the moment when you pause between breaths. The extended pause between breaths (respiratory pause) is the best time to fire the shot(s).

## **Trigger Control and Follow-through**

Trigger control is the steady pressure applied directly to the rear until the hammer falls. Place your trigger finger on the trigger. After you place your trigger finger on the trigger, keep it there until you fire. After the round discharges, allow the trigger to reset forward quickly. Your trigger finger should not lose contact with the trigger.

Follow-through involves maintaining sight alignment before, during, and after firing a round. You must maintain proper grip, shooting stance, and finger placement on the trigger. You must also acquire a sight picture each time you fire the rifle/carbine.

## **Concentration**

Concentration on the fundamentals is key to accurate and consistent shooting. For improved proficiency you should apply all the fundamentals simultaneously.

Firearms Training Required  
Material**OBJECTIVES**

- ❖ Disengage the holster retention device(s) for a holstered handgun.
- ❖ Draw the handgun upward from a holster with the retention devices unfastened.
- ❖ Acquire a proper grip on a holstered handgun.
- ❖ Secure the handgun in the holster using retention device(s).
- ❖ Use the thumb of the shooting hand on the rear of the slide to prevent cocking the semiautomatic pistol.

**UNIT 5: DRAWING AND HOLSTERING A HANDGUN****LESSON 1 | DRAWING AND HOLSTERING A HANDGUN**

**LESSON GOAL:** At the end of this lesson, you will understand drawing and holstering a handgun.

**Drawing a Handgun**

*Handgun* refers to either the revolver or the semiautomatic pistol. The procedures are the same for both weapons. To draw a handgun properly, start in the shooting stance, hands near waist level, away from your weapon. On command, disengage the safety and holster retention devices and establish a proper grip.

*To attain the proper grip, you should perform the following steps:*

**Section Vocabulary*****handgun***

1. Keep your hand high on the backstrap.
2. Wrap your fingers around the grip.
3. Draw the handgun in an upward motion, keeping your trigger finger outside the trigger guard and off the trigger.
4. Lift the handgun upward so its muzzle clears the top of your holster. (Remember to keep your trigger finger outside the trigger guard.)
5. Thrust the muzzle straight toward the target as the support hand joins the shooting hand and firearm to form the proper two-handed shooting grip. If no threat is present, keep the muzzle pointed in a safe direction.

**Holstering a Handgun**

*To holster a handgun, you should do the following:*

1. Maintain a proper grip and keep your finger off the trigger and outside the trigger guard.
2. In the reverse order from drawing, smoothly return the handgun to your holster until you seat it properly.
3. Align the retention device components, and secure them together until locked.

**Note:** It is recommended for the semiautomatic pistol to use the thumb of your shooting hand on the rear of the slide to prevent the slide from moving to the rear while holstering.



## UNIT 6: LOADING AND UNLOADING

### LESSON 1| REVOLVER

#### OBJECTIVES

- ❖ Insert ammunition into a speed loader for a revolver.
- ❖ Point the muzzle of the revolver in a safe direction.
- ❖ Disengage the revolver's cylinder release latch.
- ❖ Push/press the revolver's cylinder out of frame alignment.
- ❖ Insert ammunition into the revolver's cylinder by hand.
- ❖ Insert the ammunition into the revolver's cylinder using a speed loader.
- ❖ Extract the spent revolver cartridge casings.
- ❖ Inspect the cylinder chambers to ensure that all spent cartridge casings have been extracted.

**LESSON GOAL:** At the end of this lesson, you will understand the steps to load and unload a revolver.

#### Loading a Revolver

Select and adjust a gun belt to fit your waist. The belt should include a holster, belt keepers, speed loaders and speed loader case. Carry your speed loader case between your belt buckle and holster on your weapon side. For training and qualification, carry your extra ammunition in your shooting-side pants pocket.

*Perform the following steps to fill a speed loader:*

1. Inspect ammunition for proper caliber and defects.
2. Hold the speed loader in the fingers of your support hand so the charge holes face upward.
3. Unlock the speed loader.
4. With your shooting hand, place cartridges rim down in the charge holes.
5. Lock the cartridges in the speed loader.
6. Properly store the speed loader in the speed loader pouch.

*To load a revolver, follow these steps:*

1. Keep your finger outside the trigger guard.
2. Always keep the muzzle pointed in a safe direction.
3. Open the cylinder.
4. Locate and operate the cylinder release latch.
5. Place the revolver frame in your support hand, and then push/press the cylinder out of the frame with the ring and middle fingers of your support hand.
6. Cradle the revolver in your support hand just above your waistline, close to your body.

#### *Hand Loading*

1. With your two center fingers holding the cylinder open and your pinky and index fingers controlling the frame, position the revolver so its muzzle points at the ground.
2. Hold one cartridge between the thumb and index finger of your shooting hand.
3. Push the cartridge into a chamber of the cylinder.
4. With your thumb and fingers on the cylinder and barrel pointed towards the ground, rotate the cylinder and continue inserting cartridges until the cylinder chambers are full.
5. When you have loaded all chambers, push the cylinder closed with your support hand thumb.
6. As you remove your two center fingers, rotate the cylinder until it locks in place.

### *Partial Hand Loading*

When loading less than six rounds, place each round together, leaving no space in between rounds. For revolvers, where the cylinder rotates counter clockwise, the first round should be placed to the right of the top strap so the cylinder can rotate and place a live round in front of the barrel in line with the firing pin. For revolvers where the cylinder rotates clockwise, the first round should be placed to the left of the top strap so the cylinder can rotate and place a live round in front of the barrel in line with the firing pin. As you close the cylinder, it should be positioned so that the rounds fire in succession. (Figure 6-1)



(Figure 6-1)  
*Partial Load*

### *Speed Loading*

1. Grasp the loader's turn or push knob with the first three fingers of your shooting hand.
2. Align the cartridges protruding from the speed loader with the chambers in the cylinder.
3. Insert the cartridges as a unit into the chambers.
4. Turn or push the release knob so all the cartridges fall into the cylinder.
5. Allow the speed loader to drop to the ground.
6. Push the cylinder closed with your support hand thumb.
7. Use your support hand's thumb and forefinger to rotate the cylinder until it locks into place.



(Figure 6-2)  
*Cylinder placement with partial load*

*Unloading*

1. Hold the revolver in your shooting hand, and point it in a safe direction.
2. Locate and operate the cylinder release latch.
3. Open the cylinder by pushing it from the frame. (Figure 6-2)
4. With your support hand under the trigger guard, use the two center fingers of your support hand to push open the cylinder and your index and little fingers to control the frame. (Place your index finger over the top strap and your pinky finger over the hammer.)
5. To unload the empty casings, cradle the revolver in your support hand. Then, hold the revolver vertically with its muzzle pointed up and push down on or strike the ejector rod using your thumb or the open palm of your shooting hand to eject the casings. Let the casings fall directly to the ground. Do not catch them. After unloading the revolver, visually inspect the cylinder chambers to ensure they are all empty.

**UNIT 6: LOADING AND UNLOADING**Firearms Training Required  
Material**LESSON 2 | SEMIAUTOMATIC PISTOL****OBJECTIVES**

- ❖ Load the magazine for the semiautomatic pistol.
- ❖ Point the muzzle of the semiautomatic pistol in a safe direction.
- ❖ Insert a loaded magazine into the magazine well of the semiautomatic pistol.
- ❖ Chamber a cartridge with the semiautomatic pistol.
- ❖ Remove the magazine from the semiautomatic pistol
- ❖ Eject the cartridge from the chamber of the semiautomatic pistol.

**LESSON GOAL:** At the end of this lesson, you will understand the steps to load and unload a semiautomatic pistol.

Select and adjust a gun belt to fit your waist. The belt should include a holster, belt keepers, and a magazine pouch. Carry the magazine pouch on the support side in a vertical position. When placing magazines in the pouch, face the front of the magazine toward the center of your body.

*To load a magazine, perform the following steps:*

1. Inspect ammunition for proper caliber and defects.
2. Hold the magazine with the follower facing up.
3. Pick up the ammunition and place the cartridge on the follower so its rim faces the back of the magazine, and sits in front of the magazine lips.
4. With your thumb, push the cartridge down to depress the follower into the magazine. Continue pressing down until the cartridge is under the magazine lips.
5. Continue filling until the magazine is full. Place only the correct number of rounds in the magazine. Do not add extra rounds.
6. Tap the back of the magazine on your palm to assure that the cartridges are seated.
7. Properly store the magazine in its pouch.

*To load a semiautomatic pistol, use your shooting hand to draw the pistol from your holster. While doing so, always keep the barrel pointed in a safe direction.*

1. Open the magazine pouch with your support hand, and remove a magazine.
2. While pulling up on the magazine, place your index finger along the front of the magazine.
3. Holding the weapon in your shooting hand, bring it close to your body and angle the magazine well slightly inward.
4. Use your index finger to guide the magazine into the magazine well.
5. Push the magazine into the magazine well with enough force to lock the magazine into place.
6. Chamber a round by pulling the slide all the way to the rear and releasing, letting the slide travel forward on its own (slingshot; do not ride the slide forward).
7. De-cock/disengage if applicable.

The process of de-cocking varies, depending on the semiautomatic pistol's type: For Smith and Wesson, Beretta, and Ruger pistols, push the de-cock/safety lever down and then up with the thumb of your support hand. For a pistol with spring-loaded de-cock/safety lever, push the lever down with your shooting hand thumb and release. For Sig Sauer and HK pistols, push the de-cock lever down with your shooting hand and release.

To unload an equipped semiautomatic pistol, you should first engage the safety and then remove the magazine, holding the pistol in your shooting hand with the trigger finger outside the trigger guard. Press the magazine release button with your shooting hand thumb. Let the magazine fall to the ground. Do not attempt to catch it.

To eject the round from the chamber, use your support hand thumb and index finger to grab the slide and pull it to the rear several times. As you pull the slide back for the last time, push the slide stop up with your shooting hand thumb until the slide locks to the rear in the open position. Keep the muzzle pointed in a safe direction at all times. Make sure that your hand or fingers do not cover the pistol's ejection port. With the slide locked back, tilt the weapon and physically and visually inspect to make sure the chamber and magazine well are empty.

### *Empty Gun Reload*

When the slide locks back due to an empty gun, you must reload. Remove your finger from the trigger. Press the magazine release, which allows the empty magazine to fall to the ground; do this while bringing the gun close to your body, angling the magazine well slightly inward. At the same time, retrieve a loaded magazine with your support hand and insert it into the magazine well. Chamber a live round and reassess the threat.

**UNIT 6: LOADING AND UNLOADING****LESSON 3 | SHOTGUN****OBJECTIVES**

- ❖ Hold the shotgun by the stock when loading.
- ❖ Engage/move the safety.
- ❖ When loading the shotgun, point the barrel in a safe direction.
- ❖ Move the fore-end/slide forward, away from the receiver.
- ❖ Insert shotgun shells into the magazine tube.
- ❖ Chamber a shell when shells are inserted into the magazine tube of the shotgun.
- ❖ Hold the loaded shotgun by the grip.
- ❖ Engage the action/slide release of the loaded shotgun.
- ❖ Remove any chambered shell through the ejection port of the shotgun.
- ❖ Remove the shell(s) from the magazine tube of the shotgun.
- ❖ Inspect the chamber and magazine tube of the unloaded shotgun to ensure that no shell remains.

**LESSON GOAL:** At the end of this lesson, you will understand the steps to load and unload a shotgun.

*Perform these steps to load a shotgun:*

1. Grip the shotgun by the stock with your shooting hand.
2. Ensure the safety is engaged.
3. While gripping the shotgun, keep your trigger finger alongside the frame and keep the barrel pointed in a safe direction.
4. With your support hand, grasp the fore-end/slide and move it forward forcefully until the action locks into place.

*You are now ready to load the ammunition:*

1. Point the muzzle in a safe direction.
2. Choose the proper ammunition for your shotgun by finding the gauge on the headstamp.
3. Hold the shell in your support hand, and insert it into the magazine tube through the bottom of the receiver, crimped end first and brass to the rear.
4. Use your thumb to push the shell until it locks or clicks into the magazine tube.
5. Repeat Steps 1 through 3 until your magazine tube is full.

**Section Vocabulary**

*tactical load*

*To chamber a round:*

1. Hold the shotgun stock in your shooting hand, with its barrel pointed in a safe direction.
2. Depress the fore-end/slide release with your shooting hand index finger.
3. With your support hand, grip the fore-end/slide from underneath and pull it all the way to the rear. This moves a shell from the magazine tube onto the carrier.
4. Push the fore-end/slide forward forcefully until it locks in place. This closes the action and chambers a shell.

Make sure that none of your fingers are between the rear of the fore-end and the receiver. This can cause injury.

*To unload your shotgun:*

1. Engage the safety.
2. Hold your shotgun by the grip with your shooting hand, and point the muzzle in a safe direction.
3. With a round in the chamber, depress the action/slide release with your trigger finger.
4. Grip the fore-end/slide with your support hand.
5. Slowly pull the fore-end/slide to the rear until you expose the shell.
6. With your support hand, reach over the top and remove the chambered shell.
7. With the fore-end/slide two-thirds to the rear, push the shell carrier up into the receiver.
8. Place your support hand on the rear of the fore-end/slide, covering the loading port as you pull the slide to the rear and catch the shell from the magazine loading port.

To remove the remaining shells from the magazine tube, you should place your support hand thumb and index finger inside the receiver through the loading port and press the shell latch/stop against the receiver. This releases a round from the magazine tube. When you clear all rounds from the magazine tube, visually and physically inspect the chamber and magazine tube to make sure that there are no shells in the chamber.

**Tactical Loading**

A **tactical load** is a technique used to reload in a tactical situation. (Tactical loading is the preferred method.)

1. Point your shotgun's barrel in a safe direction or at your target.
2. While gripping your shotgun, keep your trigger finger alongside the frame. Pull the fore-end/slide to the rear to open the ejection port.
3. Wrap your support hand under your weapon, holding one round just below the ejection port opening, brass end toward the rear.
4. Roll the live round into the weapon through the open ejection port.
5. Close the action by pushing the fore-end/slide forward with your support hand, chambering the round.
6. With your support hand load the other rounds into your weapon through the loading port into the magazine tube.

## UNIT 6: LOADING AND UNLOADING

### LESSON 4 | SEMIAUTOMATIC RIFLE/CARBINE

#### OBJECTIVES

- ❖ Insert a loaded magazine into the magazine well of the semiautomatic rifle/carbine.
- ❖ Chamber a cartridge in the semiautomatic rifle/carbine.
- ❖ Remove the magazine from the semiautomatic rifle/carbine.
- ❖ Extract the cartridge from the chamber from a semiautomatic rifle/carbine with the magazine removed.
- ❖ Lock the action in the “open” position on an unloaded semiautomatic rifle/carbine.
- ❖ Inspect the unloaded semiautomatic rifle/carbine for any cartridges with the action locked in the “open” position.

**LESSON GOAL:** At the end of this lesson, you will understand the steps to load and unload a semiautomatic rifle/carbine.

*To load a semiautomatic rifle/carbine, follow the following steps:*

1. Load the magazine.
2. As you prepare the rifle/carbine, keep it pointed in a safe direction. Tap the back of the magazine to ensure that you seat the rounds properly.
3. Hold the rifle/carbine by its pistol grip with your shooting hand. Make sure to keep your trigger finger alongside the frame.
4. Engage the safety.
5. With the magazine properly aligned with the magazine well, push the magazine into the magazine well until the magazine locks into place.
6. To make sure the magazine is locked in place, try to pull it out.
7. Keeping the weapon pointed in a safe direction, pull the charging handle fully to the rear and release it. This allows the bolt to go forward, feeding a round into the chamber.

*To unload the semiautomatic rifle/carbine, keeping the firearm pointed in a safe direction, you should perform the following steps:*

1. Engage the safety.
2. Grip the rifle/carbine firmly and steadily so you do not lose control or drop the weapon as you unload.
3. Remove the magazine by depressing the magazine release button. Let the magazine drop to the ground.
4. To extract the cartridge from the chamber, you should grip the charging handle and pull the charging handle fully to the rear and release. These actions should eject any round in the chamber. Do not attempt to catch the ejected cartridge.
5. If the specific weapon you are using does not automatically lock the bolt back, you should pull the charging handle to hold the bolt to the rear. While holding the charging handle to the rear, you should depress the lower portion of the bolt lock lever. Then, depress the upper portion of the bolt lock lever to release the charging handle. (Reset the charging handle back into the upper receiver.) This locks the action in the open position.
6. With the bolt locked back and the chamber open and fully visible, physically and visually inspect the chamber and magazine well to make sure that no rounds remain in the chamber.



**UNIT 7: USE OF COVER**Firearms Training Required  
Material**LESSON 1 | USE OF COVER****OBJECTIVES**

- ❖ Define cover.
- ❖ Define concealment.
- ❖ Identify tactical considerations in the use of cover and concealment.
- ❖ Identify factors to consider before moving.
- ❖ Use cover properly when given a threat.
- ❖ Identify appropriate shooting stances from behind cover.

**Section Vocabulary***concealment**cover*

**LESSON GOAL:** At the end of this lesson, you should be able to identify and know the difference between cover and concealment and be able to apply proper firearms techniques when using cover. (See Figures 7-1 through 7-4.)

Using cover and concealment can be critical to a Class “G” licensee winning a confrontation.

**Cover** is any object or obstacle that creates a bullet-resistant barrier between you and a threat. It includes, but is not limited to, such things as a solid concrete wall, a vehicle’s engine block, or a concrete telephone pole.



(Figure 7-1)



(Figure 7-2)

**Concealment** is any object or group of objects that creates a visual barrier between you and a threat but may not stop a projectile. Examples include bushes, trees, and cars. The purpose of concealment is to hide your exact location. Cover can be concealment, but concealment is not necessarily cover.

Cover should be chosen for its bullet-stopping capabilities, not its size. Walls and doors made of materials that bullets can penetrate may serve as concealment. Do not consider them cover, however. The objective of cover is to save your life by stopping or deflecting bullets and to provide a safer environment while you evaluate a situation.

Tactical considerations in using cover include using cover whenever possible, and reloading behind cover whenever possible while observing the threat.

Consider these factors to determine appropriate cover:

**size**—Ideally, the object should be large enough to fully conceal your body (for example, a vehicle or concrete wall). However, any cover is better than no cover.

**density**—The cover should be capable of stopping a projectile.

**location**—Choose cover that is tactically sound and positions you to engage a threat.

**versatility**—Choose cover that gives you the most options, such as cover that allows you to use your shooting hand rather than your support hand or cover that enables you to change heights or shooting stances.

There are several factors to consider before moving to cover. For instance, never change your cover just for the sake of change. Select your next position before you move. Move closer only to gain a tactical advantage. Move using concealment—cars, trees, bushes—if available. You may need to run, crawl, or “duck walk” to reach cover. Move if you need to reach a safer location. Reload your firearm behind cover, when possible.



(Figure 7-3)



(Figure 7-4)

When moving to cover, scan the area first. Your weapon should be in a ready position.

You should be ready to engage the threat at any time, even while moving. Keep your finger off the trigger, outside the trigger guard. Be aware of foot placement. Move quickly and decisively; use concealment if available. Always be aware of alternative options. Don’t lock yourself into a bad position. To properly use cover, keep your body and your firearm behind cover. Do not expose your

body unnecessarily. Do not let the muzzle of your firearm extend beyond the cover object.

Exploit distance and angles. Do not “crowd” your cover. You do not have to be right behind your cover to use it effectively. Remember to judge your position of cover from your adversary’s angle or viewpoint and keep your firearm and body off the cover. Leaning on your cover decreases your mobility, and it increases your chance of being hit by direct fire or a ricochet, or by scattered debris when projectiles impact your cover. Remember that ricochet or debris may disable your firearm. Alter your shooting position from behind cover whenever possible. Muzzle flash may reveal your location, especially at night.

### **Stances from Behind Cover: Handgun Barricade Standing (Roll-Out Method)**

*Follow this procedure for firing your handgun from the standing barricade position:*

1. Start away from cover in your basic stance.
2. Draw your firearm from your holster, keeping your finger off the trigger; move to cover and identify your target.
3. Stay completely behind the barricade using it for cover.
4. Use your basic shooting position.
5. Roll out to your shooting-hand side. Expose only a small portion of your shoulder and head. Keep your firearm away from and behind the barricade. Do not let your firearm or hands rest on or touch the barricade.

### **Kneeling Barricade (Roll-Out Method)**

*Use this procedure for firing your handgun from the kneeling barricade position.*

1. Start away from cover in your basic stance.
2. Draw your firearm from your holster, keeping your finger off the trigger; move to cover and identify your target.
3. Stay completely behind it and use it for cover.
4. Use a kneeling position behind cover.
5. Roll to your shooting-hand side. Remember to expose only a small portion of your shoulder and head and keep your firearm away from and behind the barricade. Also, do not let your firearm or hands rest on or touch the barricade.

**Positions from Behind Cover: Shotgun and Rifle/Carbine  
Barricade Standing (Roll-Out Method)**

*Use this procedure to fire a shotgun or rifle/carbine from the standing barricade position:*

1. Start away from cover in your basic stance.
2. Keeping your finger off the trigger, move to cover and identify your target.
3. Stay completely behind the barricade using it for cover.
4. Roll out to your shooting-hand side. Remember to expose only a small portion of your shoulder and head and keep your firearm away from and behind the barricade. Also, do not let your firearm or hands rest on or touch the barricade.

**Kneeling Barricade (Roll-Out Method)**

*Use this procedure for firing your shotgun or rifle/carbine from the kneeling barricade position:*

1. Start away from cover in your basic stance.
2. Keeping your finger off the trigger, move to cover, take a kneeling position and identify your target.
3. Stay completely behind the barricade, using it for cover.
4. Roll to your shooting hand side. Remember to expose only a small portion of your shoulder and head and keep your firearm away from and behind the barricade. Also, do not let your firearm or hands rest on or touch the barricade.

**UNIT 8: WEAPONS MALFUNCTIONS**Firearms Training Required  
Material**LESSON 1 | REVOLVER MALFUNCTIONS****OBJECTIVES**

- ❖ Keep the barrel of a weapon with a malfunction pointed in a safe direction.
- ❖ Remove your finger from the trigger of a weapon with a malfunction.
- ❖ Identify revolver malfunctions.
- ❖ Identify a squib load in a revolver.
- ❖ Correct the revolver malfunction using the proper technique.

**LESSON GOAL:** At the end of this lesson, you will understand malfunctions that may occur when using a revolver and how to correct them.

This section identifies types of malfunctions that may occur as you fire your weapon and teaches you how to correct them. Knowing how to correct problems with your firearm is imperative: It may save your life. Malfunctions caused by ammunition can usually be prevented if the ammunition is inspected for defects before use.

A **malfunction** is a condition that prevents a weapon from operating normally. Before trying to correct a malfunction on the weapons covered in this chapter, remember to perform the following steps:

1. Keep the barrel pointed in a safe direction.
2. Remove your finger from the trigger.
3. Identify the kind of malfunction and the proper technique for correcting it.

**Revolver Malfunctions**

Revolver malfunctions include failure to fire, misfire, a squib load, a casing caught under the extractor, or a frozen or improperly closed cylinder.

A **squib load** occurs when there is no powder or a partial burn of powder and the primer ignites. The result is incomplete propulsion of the bullet, which may lodge the projectile in the barrel. **THIS IS A MAJOR SAFETY HAZARD.**

A distinct sound is associated with a squib load. It is not as loud or forceful as the sound of a regular round firing. You hear a pop instead of a bang and feel much less recoil.

If this happens during training, do the following:

1. Stop firing.
2. Keep your weapon pointed downrange.
3. Raise your support hand.
4. Wait for an instructor to take the weapon.

Instructors are responsible for clearing this malfunction.

During a deadly force encounter, go to a secondary weapon (if available). Retreat and move to cover. This description of a squib load and the procedure for handling it is the same for the semiautomatic pistol and rifle/carbine covered in this section.

**Section Vocabulary***frozen cylinder**malfunction**squib load*

## Clearing Revolver Malfunctions

Suppose you pull the trigger and the hammer falls, but the round fails to detonate. You are experiencing a failure to fire. The following conditions cause a failure to fire:

The revolver is not loaded. To fix this, load the revolver.

A bad primer causes a misfire; that is, the primer fails to fire after the hammer nose or firing pin strikes it. The result is a dead round.

Dirt and debris may cause a malfunction. To fix this, you must unload and clean the weapon.

The rebound spring has been altered to make the trigger easier to pull, resulting in a light hammer fall. Only a certified armorer can fix this problem.

The strain screw has been backed out, cut, loosened, or altered to make the trigger easier to pull. The result is a light hammer fall. Only a certified armorer can fix this problem.

No student should alter a weapon. All weapons should meet factory standards.

The firing pin or hammer nose breaks; a certified armorer must fix it.

If the firing pin breaks during training, keep the weapon pointed in a safe direction, and raise your support hand to summon the range instructor. If this happens during a deadly force encounter, go to your secondary weapon (if available). Retreat and move to cover.

If a misfire occurs in training, keep the weapon pointed in a safe direction, pause momentarily, and then pull the trigger again. When you empty the cylinder, you will see an indentation on the primer of the round that caused the misfire. The projectile is still attached to the casing.

If a misfire occurs during a deadly force encounter, immediately pull the trigger again. If the weapon still fails to fire, use your secondary weapon (if available), and then retreat and move to cover.

Unloading the revolver sideways or failing to fully depress the extractor rod when unloading it may cause a casing to be caught under the extractor. You can prevent this malfunction by making sure to point the muzzle straight up when unloading the revolver. If it does occur, press and hold the extractor rod completely to the rear, with the cylinder open. Then, dislodge the casing from the cylinder using your finger.

A **frozen cylinder** is one that does not rotate. Causes can include dirt or debris under the extractor that locks the cylinder so it cannot rotate. To solve this problem, clean under the extractor. Bad ammunition (high primer) can also cause a frozen cylinder. The primer on the cartridge protrudes above the headstamp. This situation can be dangerous: opening the cylinder roughly can ignite the primer. To prevent this problem, check your ammunition before loading.

If the cylinder freezes or a loose extractor rod has backed out in the frame during training, you should keep your weapon pointed in a safe direction and raise your support hand to summon an instructor. The instructor will take the revolver and clear the ammunition.

Checking your revolver and ammunition before loading, as well as keeping your weapon clean, can prevent most malfunctions.

**UNIT 8: WEAPONS MALFUNCTIONS**Firearms Training Required  
Material**LESSON 2 | SEMIAUTOMATIC PISTOL  
MALFUNCTIONS****OBJECTIVES**

- ❖ Identify the types of semiautomatic pistol malfunctions that may occur.
- ❖ Identify a squib load in a semiautomatic pistol.
- ❖ Correct the semiautomatic pistol malfunction using the proper technique(s).

**LESSON GOAL:** At the end of this lesson, you will understand malfunctions that may occur when using a semiautomatic pistol and how to correct them.

Semiautomatic pistol malfunctions include a squib load, a failure to fire, a failure to feed, a failure to eject, a double feed, or a failure to extract. The leading cause of malfunctions in semiautomatic weapons is the failure to properly seat the magazine.

You can clear most malfunctions from the pistol (excluding a squib round) using two clearance methods. If available, move to cover to clear a malfunction in an actual armed confrontation.

**Section Vocabulary***double feed (handgun)**failure to eject (stovepipe)**failure to extract**failure to feed**failure to fire***Phase 1 Clearance: Immediate Action Drill**

Use Phase 1 Clearance to fix failure to feed, failure to fire, stovepipe, and failure to extract malfunctions. The easiest way to remember this method is to learn the phrase Tap, Rack, Ready, Fire (if necessary).

When a malfunction occurs, you should perform the following steps:

1. Use your support hand to tap (**Tap**) the bottom of the magazine into the magazine well. If the magazine is not fully seated, tapping will seat it.
2. Reach up to the slide with your support hand, pull the slide to the rear, and then release it.  
This is the same action you use when loading your weapon (Rack). It extracts and ejects a bad round (if necessary) and chambers a new round.
3. Ready—In an actual armed confrontation, you must assess the situation. You either re-engage the subject if he or she remains a threat, or issue commands if the subject surrendered during the clearance drill.
4. Fire if necessary.

**Phase 2 Clearance: Immediate Action Drill**

If a Phase 1 Clearance does not clear the malfunction or the malfunction is a double feed, use a Phase 2 Clearance. A Phase 2 Clearance is more detailed and time consuming.

1. Lock the slide to the rear to release pressure on the recoil guide/spring and magazine.
2. Depress the magazine release; forcibly strip the magazine from the magazine well with the support hand.
3. Rotate the pistol towards the ejection port side and with your support hand, work the slide back and forth until you clear the barrel and chamber of any rounds or obstructions.
4. Place a new magazine in the magazine well, and use a sharp upward motion to seat the magazine.

5. Reach up to the slide with your support hand, pull the slide to the rear, and then release it (sling shot). This chambers a round.
6. Ready—Assess the situation. Re-engage the subject if he or she is still a threat, or issue verbal commands.
7. Fire if necessary.

Squib load (See the information on squib load in the Revolver section.)

A **failure to fire** occurs when the trigger is pulled, but the round fails to detonate. The following conditions cause a failure to fire:

The safety is engaged. Disengage the safety.

Failure to chamber a round. Correct this malfunction with the Phase 1 Clearance method—Tap, Rack, and Ready.

The magazine is not seated in the magazine well. Correct this malfunction by tapping the magazine into the magazine well.

The primer fails to fire after the firing pin or striker hits it. The result is a misfire and a dead round. Correct this malfunction with the Phase 1 Clearance method—Tap, Rack, and Ready.

In a **failure to feed**, the cartridge fails to feed into the chamber. This occurs when the magazine is not fully seated. Use the Phase 1 Clearance method—Tap, Rack, and Ready—to correct this malfunction, or insert a new magazine.

**Failure to eject**, often called a *stovepipe*, occurs when a fired cartridge case does not completely eject. The most common causes are a weak powder charge (bad ammunition), a dry weapon (not enough lubrication), and, if while firing, the shooter does not provide enough resistance for the slide to operate (limp wrist). Use the Phase 1 Clearance method—Tap, Rack, and Ready—to correct this malfunction. (Figure 8-1, 2)



(Figure 8-1)  
*Stovepipe*

A **double feed** is a failure to extract the round in the chamber and a new round being fed from the magazine. Causes include damaged or improperly dimensioned magazine lips or a faulty cartridge interrupter (in weapons with tubular magazines).

To clear a double feed, you must use the Phase 2 Clearance method:

1. Lock the slide to the rear.
2. Depress the magazine release and forcefully strip the magazine from the magazine well.
3. Rotate the pistol towards the ejection port side and with your support hand, work the slide back and forth until you clear the barrel and chamber of any rounds or obstructions.
4. Reinsert a magazine and make sure it is fully seated.
5. Pull back on the slide, and release it to chamber a round (sling shot).
6. Assess the situation.
7. Fire if necessary.



(Figure 8-2)  
*Double Feed*

***Failure to extract*** occurs when the pistol fails to extract a spent casing from its chamber. The causes of this malfunction include a weak powder charge, dirt behind the extractor, a dirty chamber, a broken extractor, a damaged or worn rim on the case, or an over-expanded or cracked case.

To clear this malfunction, use the Phase 1 Clearance method. If you do not succeed, try the Phase 2 Clearance method. If the extractor is worn or broken, a certified armorer must repair the weapon. If the weapon is dirty, it must be cleaned.

During qualification, you must clear weapon malfunctions and continue firing. If you cannot return your weapon to firing condition after performing an immediate action drill, summon an instructor.



## UNIT 8: WEAPONS MALFUNCTIONS

### LESSON 3 | SHOTGUN MALFUNCTIONS

#### OBJECTIVES

- ❖ Identify the shotgun malfunction.
- ❖ Correct the shotgun malfunction using the proper technique(s).

**LESSON GOAL:** At the end of this lesson, you will understand malfunctions that may occur when using a shotgun and how to correct them.

Shotgun malfunctions include the following: the shell fails to load from the magazine tube, the fore-end/slide fails to close fully, failure to feed, double feed, stacked feed, failure to fire, failure to extract, failure to open, failure to eject, failure to close, and stovepipes.

#### Clearing Shotgun Malfunctions

Shells fail to load into the magazine tube when a bent carrier prevents the shell from aligning with the magazine tube opening, the wrong ammunition is used, or the shell stop is defective. To correct this malfunction, raise your support hand, keep your weapon pointed downrange, and

#### Section Vocabulary

*double feed (shotgun)*

*stacked feed*

summon the instructor to assist you.

The fore-end/slide may fail to close fully. This malfunction results from a bent action bar, a jammed or bent shell stop, a foreign object or broken part in the action, or the shooter's failure to push the fore-end/slide completely forward. If one of the first three reasons caused the malfunction, raise your support hand, keep your weapon pointed downrange, and wait for an instructor to assist you. If you did not push the fore-end/slide completely forward, forcefully push the fore-end/slide forward, then lock it into place.

If the slide is cycled but the round does not feed, there is a failure to feed. The following conditions may cause a failure to feed:

The shell stop is holding back the shell.

The magazine follower is sticking in the magazine tube.

An improperly operating carrier prevents alignment of the shell.

Ammunition is inverted.

The fore-end or slide is not cycled completely.

The weapon is not loaded.

- ❖ If one of the first four reasons caused the malfunction, raise your support hand, keep your weapon pointed downrange, and summon an instructor to assist you. If either of the last two reasons caused the malfunction, completely cycle the slide, then load the weapon.

A *double feed* occurs when the shell stop fails to retain a shell in the magazine tube after one has been moved onto the carrier. The action will not close. To correct this malfunction, you should press down on the nose of the shell on the carrier to expose the base of the shell still partially in the magazine tube. With your finger, push that shell back into the magazine tube until it locks in place. You must do this through the ejection port.

A *stacked feed* occurs when a round is in the chamber and the action is closed. The shell latch fails to keep a round in the magazine tube. Instead, it moves the round onto the carrier. The weapon still operates but you cannot load rounds until you remove the one in the chamber. You can correct this in two ways:

1. Fire the chambered round and cycle the slide.
2. If you cannot fire the round, engage the safety and remove your finger from the trigger guard. Depress the slide release and apply sufficient force to pull the fore-end/slide to the rear.

If the trigger is pulled, but the round fails to fire, this is a failure to fire. The following conditions cause a failure to fire: the safety is on, the chamber is empty, the round is bad, or the firing pin is broken. If a broken firing pin is the problem, a certified armorer must repair it.

To correct this malfunction,

1. If the safety is on, disengage it.
2. If the weapon is empty, load it.
3. If the weapon misfires, immediately cycle the weapon and fire, if appropriate, or assume the ready position on the target.
4. If taking these steps fails to correct the problem, raise your support hand, keep your weapon pointed downrange, and summon an instructor to assist you.

The shotgun fails to extract a spent casing from its chamber while it tries to feed a new round into the chamber at the same time. Called failure to extract, the causes of this malfunction include a broken extractor or a worn extractor hook. To correct this malfunction, raise your support hand, keep your weapon pointed downrange, and ask for help from an instructor. A certified armorer must repair a broken extractor or worn extractor hook.

A failure to open occurs when the shotgun's fore-end/slide will not cycle, and the shotgun will not open. Causes include not firing a round to release the fore-end/ slide, failing to depress the fore-end/slide release, or an improperly maintained weapon.

If this malfunction results from improper maintenance, engage the safety and place your finger outside the trigger guard, then raise your support hand, keep your weapon pointed in a safe direction, and ask for the instructor to help you. If the malfunction occurs for the two other reasons, you can usually correct it by properly cycling the fore-end/slide.

A failure to eject occurs when an ejector is missing or broken, the shell is swollen and will not extract, or an ejector is bent or improperly positioned. To correct this malfunction, engage the safety by placing the finger outside the trigger guard, then raise your support hand, keep your weapon pointed in a safe direction, and ask an instructor to assist you.

When the bolt and ejection port trap a partially ejected shell, a stovepipe occurs. You could cause this problem if you do not cycle the action properly. To correct it, pull the slide all the way to the rear, and free the shell by using your hand. Then, cycle the slide forward to load the chamber.

If your shotgun malfunctions in the field, you should immediately switch to your handgun.

## UNIT 8: WEAPONS MALFUNCTIONS

### LESSON 4 | SEMIAUTOMATIC RIFLE/CARBINE MALFUNCTIONS

#### OBJECTIVES

- ❖ Identify the semiautomatic rifle/carbine malfunctions.
- ❖ Identify a squib load in a semiautomatic rifle/carbine.
- ❖ Transition to a secondary means of defense when a squib load occurs.
- ❖ Correct the malfunction of the semiautomatic rifle/carbine using the proper technique(s).

**LESSON GOAL:** At the end of this lesson, you will understand malfunctions that can occur when using a semiautomatic rifle/carbine and how to correct them.

Semiautomatic rifle/carbine malfunctions include a squib load, failure to fire, failure to feed, failure to extract (double feed), or failure to eject (stovepipe).

Most malfunctions from a rifle/carbine (excluding a squib round) can be cleared using two techniques:

#### 1) Phase 1 Clearance: Immediate Action Drill

Use Phase 1 Clearance to fix failure to feed, failure to fire, stovepipe, and failure to extract malfunctions. The easiest way to remember this method is to learn the phrase Tap, Rack, Ready, Fire if necessary. In an actual armed confrontation, Class “G” licensees should transition to a

secondary weapon and clear the malfunction when safe to do so.

When a malfunction occurs perform the following steps:

1. Use your support hand to tap (Tap) the bottom of the magazine into the magazine well. If the magazine is not fully seated, tapping will seat it.
2. Remain in your stance with your weapon still pointed at the target.
3. Reach up to the charging handle with your support hand, pull it to the rear, and release (sling shot).
  - a. This is the same action you use when loading the weapon (Rack). It extracts and ejects a bad round (if necessary), and/or chambers a new round.
4. Ready — In an actual armed confrontation, you must assess the situation. You should either re-engage the threat or issue commands if the suspect surrenders during the clearance drill.
5. Fire if necessary.

#### 2) Phase 2 Clearance: Immediate Action Drill

If Phase 1 Clearance does not clear the malfunction or the malfunction is a double feed, use Phase 2 Clearance.

1. Lock the bolt to the rear to release pressure on the magazine.
2. Depress the magazine release; forcibly strip the magazine from the magazine well.
3. Remain in your stance with your weapon still pointed at the target.
4. With your support hand, work the charging handle back and forth until you clear the barrel and chamber of rounds or obstructions.
5. Place a new magazine in the magazine well, and use a sharp upward motion to seat the magazine.
6. Reach up to the charging handle with your support hand, pull it to the rear, and release (sling shot). This chambers a round.

7. Ready—Assess the situation. Re-engage the subject if he or she remains a threat, or issue verbal commands.
8. Fire if necessary.

Squib load (See the information on squib load in the Revolver section.)

In a training situation, an instructor will take the firearm. Instructors are responsible for clearing this malfunction.

During a deadly force encounter, transition to a secondary weapon or retreat. Immediately move to cover, if available. If a Class “G” licensee’s rifle malfunctions, he or she should immediately switch to a handgun, if available.

If the trigger is pulled but the round fails to fire, this is a failure to fire. The following conditions cause a failure to fire:

The safety is engaged and you cannot pull the trigger. Disengage the safety.

Failure to chamber a round. Correct this malfunction with the Phase 1 Clearance method— Tap, Rack, Ready.

The primer fails to ignite after the firing pin strikes it. The result is a misfire and a dead round. Correct this malfunction with the Phase 1 Clearance method—Tap, Rack, Ready.

Imagine that you insert the magazine, release the bolt forward, and disengage the safety. Then you pull or squeeze the trigger, and nothing happens. You are experiencing a failure to feed. This occurs when the magazine is not fully seated in the magazine well, the magazine is empty, the magazine spring is broken, or the magazine is not loaded properly.

Take these steps immediately:

1. Tap the bottom of the magazine upward to ensure proper seating.
2. Pull the charging handle completely to the rear, and release it. This chambers a round.
3. If the magazine well is empty, insert a new magazine.
4. Ready—Assess the situation. Re-engage the subject if he or she remains a threat, or issue commands if the subject surrendered.
5. Fire if necessary.

A failure to extract round (double feed) occurs when a spent casing remains in the chamber, blocking a new round from feeding into the chamber.

To clear a double feed,

1. Lock the bolt to the rear.
2. Remove the magazine.
3. Work the charging handle back and forth until you empty the chamber.
4. Reinsert the magazine.
5. Pull the charging handle completely to the rear, and release it to chamber a round.
6. Ready—Assess the situation.
7. Fire if necessary.

A stovepipe occurs when an empty casing fails to completely eject. Causes include a weak powder charge or a dry weapon (not enough lubrication).

Use the Phase 1 Clearance method to clear the caught casing:

1. Tap the bottom of the magazine upward to ensure proper seating.
2. Pull the charging handle completely to the rear while turning the ejection port towards the ground, and release the charging handle/lever. This ejects the caught round and chambers a new round.
3. Ready—Assess the situation.
4. Fire if necessary.

**UNIT 9: WEAPONS CLEANING**Firearms Training Required  
Material**LESSON 1 | REVOLVER CLEANING****OBJECTIVES**

- ❖ Identify the proper supplies/tools to use when cleaning the revolver.
- ❖ Clean the revolver, removing all lead, powder, debris, and dirt.
- ❖ Lightly lubricate the revolver.
- ❖ Reassemble the cleaned revolver dependent upon the make and model of the weapon.
- ❖ Function check the cleaned revolver.
- ❖ Return the revolver to safe storage and/or securely re-holster the weapon.
- ❖ Appropriately dispose of all debris and contaminated/used cleaning supplies.
- ❖ Wash your hands after cleaning a revolver.

**LESSON GOAL:** At the end of this lesson, you will understand the steps to cleaning and lubricating a revolver, and the necessary supplies and tools.

Cleaning your weapon is important. A clean weapon functions properly when it is needed. Field stripping and cleaning are routine maintenance for all weapons. Before cleaning your weapon, gather the supplies and tools you need, select a well-ventilated location for cleaning, and fieldstrip the weapon.

While field stripping and cleaning your revolver, remember to take these important steps:

1. Safety check the weapon.
2. Remove live ammunition from the cleaning area.
3. Release the cylinder catch and open the cylinder.
4. Visually and physically inspect the barrel and chambers for obstructions and ammunition.

Cleaning tools—cleaning tools are caliber specific. Use the tools designated for the specific caliber of your weapon. A larger caliber cleaning brush or patch tip does not fit in a small weapon and may cause damage. A small tool may not completely clean your firearm. It is recommended that you observe the manufacturer's

guidelines.

**Solvent and lubricant**—Several types and brands of cleaners and solvents are available. Use solvent and lubricant specifically designed for firearms maintenance.

**Patches and swabs**—Consider the weapon bore when choosing patches. Different materials have different absorption qualities.

The weapon cleaning kit could include the following items; bore brush, solvent, patches (cotton patches absorb more), nylon cleaning brush, Bore Snake®, cleaning pad, gun oil/lubricant (non-penetrating), rags, pipe cleaners, and Q-tips®.

**Cleaning and Lubricating the Revolver**

1. Remove all lead, powder, debris, and dirt. These substances can cause a malfunction if they build up. Be sure to remove as much of these materials as possible.
  - a. Use a brushing technique to remove loose objects, loosen other substances, and help solvents and cleaners work better.

Brush all surfaces of your firearm.

The bore brush should clear the bore after each stroke.

Push the brush all the way in, then bring it all the way out.

Make sure to use a soft, non-marring brush on the firearm's outer finished surface.

Do not use a brass brush on the firearm's exterior: it can damage the surface.

- b. Brush with solvent. Solvents are designed to dissolve and loosen lead, powder, debris, and dirt. You can also use them to clean substances that brushing does not, such as lead, powder, or debris.
2. Pay special attention to the following areas on the revolver:
- ❖ cylinder—When the firearm discharges, it may blow powder and lead back over the cylinder's outer surface. These substances may be heavily concentrated on the cylinder's face.
  - ❖ cylinder chambers—The chambers may contain unburned powder and lead.
    - a. Insert the cleaning brush in each chamber.
    - b. Slide it back and forth several times.
  - ❖ bore—As the projectile travels down the bore, it leaves behind small amounts of material. If the projectile is lead, it leaves lead behind. If its jacket is brass, the projectile may leave some brass behind.
    - a. Insert the cleaning brush in the barrel.
    - b. Slide the cleaning brush back and forth several times.
    - c. Push the brush all the way through, then pull it all the way out.
  - ❖ area below the top strap—Lead and powder residue are deposited in this area when gases from fired rounds escape around the forcing cone.
  - ❖ firing pin hole—Observe the firing pin hole to ensure that it is free of all debris.
  - ❖ ejector rod—Clean the area around and under the ejector rod.
  - ❖ extractor—Clean the area around and under the extractor. If the extractor does not work, you cannot empty or load the weapon.
3. After brushing these parts, wipe them with a clean patch and a small amount of cleaning solvent.
  4. With a clean, dry patch, wipe all parts again to remove the solvent and debris.

You may need to repeat this action until the revolver is clean.

Lubricating your weapon is very important. Check your weapon at regular intervals to ensure it is properly lubricated. Also, check the manufacturer's recommended lubrication points and amounts. A little lubricant goes a long way. Excess lubrication can harm ammunition. Wipe it off using a clean, dry cloth.

When you finish cleaning and lubricating your revolver, you should follow these steps:

1. Reassemble the revolver.
2. Perform a function check of the revolver for proper operation.
3. Return the revolver to safe storage, or holster and secure it.
4. Properly dispose of all cleaning supplies.
5. Wash your hands with soap and water.

**UNIT 9: WEAPONS CLEANING**Firearms Training Required  
Material**LESSON 2 | SEMIAUTOMATIC PISTOL CLEANING****OBJECTIVES**

- ❖ Field strip the semiautomatic pistol based on make and model of weapon.
- ❖ Identify the proper supplies/ tools to use when cleaning the semiautomatic pistol.
- ❖ Clean the semiautomatic pistol, removing all lead, powder, debris, and dirt.
- ❖ Lubricate the semiautomatic pistol using lubricant and cloth/ patches.
- ❖ Reassemble the cleaned semiautomatic pistol.
- ❖ Function check the clean, reassembled semiautomatic pistol.
- ❖ Return the cleaned semiautomatic pistol to safe storage and/or securely re-holster the weapon.
- ❖ Appropriately dispose of all debris and contaminated/used cleaning supplies.
- ❖ Wash your hands after cleaning a semiautomatic pistol.

**LESSON GOAL:** At the end of this lesson, you will understand the steps to cleaning and lubricating a semiautomatic pistol, and the necessary supplies and tools.

While field stripping and cleaning your semiautomatic pistol, remember these important steps:

1. Safety check the weapon.
2. Remove live ammunition from the cleaning area.
3. Remove the magazine by pressing the magazine release and letting the magazine slide out of the magazine well or by stripping the magazine with your support hand. Place the magazine away from the weapon.
4. To lock the slide to the rear, pull on it and engage the slide stop or catch.
5. Visually and physically inspect the chamber, magazine well, and barrel. Look for ammunition casings and obstructions.
6. Remove the ammunition from the magazine(s).
7. Place the ammunition in a secure area away from the weapon.

It is recommended that you observe manufacturer's guidelines for cleaning your semiautomatic pistol. Make sure the tools you use do not invalidate the manufacturer's warranty or conflict with the

manufacturer's recommendations.

The weapon cleaning kit could include a bore brush, solvent, patches (cotton patches absorb more), nylon cleaning brush, Bore Snake®, cleaning pad, gun oil/lubricant (nonpenetrating), rags, pipe cleaners, and Q-Tips®.

**Cleaning Tools**—Cleaning tools are caliber specific. Use the tools designated for the specific caliber of your weapon. A larger caliber cleaning brush or patch tip does not fit in a small weapon and may cause damage. A small tool may not completely clean a large firearm.

**Solvent and Lubricant**—Several types and brands of cleaners and solvents are available. Use solvent and lubricant specifically designed for firearms maintenance.

**Patches and Swabs**—Consider the weapon bore when choosing patches. Different materials have different absorption qualities.



## Cleaning and Lubricating the Semiautomatic Pistol

1. Remove all lead, powder, debris, and dirt. These substances can cause a malfunction if they build up. Use the following processes:

- a. Brush properly—Use a back and forth brushing motion to remove loose objects, loosen other substances, and help solvents and cleaners work better.

Brush all surfaces of your firearm.

The bore brush should clear the bore completely after each stroke.

It is important to use a soft, non-marring brush on the firearm's outer finished surface. Do not use a brass brush on the firearm's exterior: it can damage the surface.

- b. Brush with solvent—Solvents are designed to dissolve and loosen lead, powder, debris, and dirt. You can also use them to clean substances that brushing does not, such as lead, powder, or debris.
  - c. Wipe all parts repeatedly to remove all of the solvent and debris until your semiautomatic pistol is clean. Use new clean, dry patches when necessary.
2. Pay special attention to the following areas of the semiautomatic pistol:
    - ❖ magazines—Clean magazines thoroughly and wipe dry. If magazines do not function properly, the firearm can malfunction.
    - ❖ bore—As the projectile travels down the bore, it leaves behind small amounts of the material it is made of. To thoroughly clean the bore, you should insert the cleaning brush into the bore's breech end, push the cleaning brush through until it clears the muzzle, and then pull it all the way out. Repeat this process until the bore of the barrel is clean.
    - ❖ recoil spring and guide—Clean thoroughly; dirt and debris hinder the weapon's blowback and cycle function.
    - ❖ slide—Clean the entire slide, outside and inside. Pay special attention to the slide rails. You can use Q-Tips.
    - ❖ extractor—Clean the extractor thoroughly. It must be able to catch the rim of a fired cartridge as the weapon cycles. If not, the next round cannot feed properly and a malfunction results.
    - ❖ firing pin hole—Observe the firing pin hole to ensure that it is free of all debris.

Lubricating your weapon is very important. Check your weapon at regular intervals to ensure it is properly lubricated. Also, check the manufacturer's recommended lubrication points and amounts.

1. Lubricate the frame or slide rails to reduce drag or friction between surfaces when the weapon cycles.
2. Lubricate any other points recommended by the manufacturer.
3. Remove excess lubrication. A little lubrication goes a long way. Excess lubrication can harm ammunition. Wipe it off using a clean, dry cloth. Heavy lubrication or solvents may destroy the primer and powder of loaded cartridges. Wipe the inside of the magazine dry; leave no lubricant.

When you finish cleaning and lubricating your pistol:

1. Reassemble the semiautomatic pistol and its magazines.
2. Perform a function check of the pistol for proper operation.
3. Return the pistol to safe storage, or holster and secure it.
4. Properly dispose of all cleaning supplies.
5. Wash your hands with soap and water.

## UNIT 9: WEAPONS CLEANING

### LESSON 3 | SHOTGUN CLEANING

#### OBJECTIVES

- ❖ Field strip the shotgun based on make and model.
- ❖ Identify the proper supplies/tools to use when cleaning the shotgun.
- ❖ Clean the shotgun, removing all lead, powder, debris, and dirt.
- ❖ Lubricate the shotgun.
- ❖ Properly reassemble the shotgun.
- ❖ Function check the cleaned, reassembled shotgun.
- ❖ Return the cleaned shotgun to safe storage and/or securely re-case the weapon.
- ❖ Appropriately dispose of all debris and contaminated/used cleaning supplies.
- ❖ Wash your hands after cleaning a shotgun.

**LESSON GOAL:** At the end of this lesson, you will understand the steps to cleaning and lubricating a shotgun, and the necessary supplies and tools.

While field stripping and cleaning your shotgun, remember to take these important steps:

1. Safety check the weapon.
2. Remove live ammunition from the cleaning area.
3. Point the weapon in a safe direction, remembering the safety rules.
4. Verify that the safety is in the on position and the magazine tube or chamber contains no ammunition.
5. Ensure that the slide is at the rear and the ejection port is open.

It is recommended that you observe manufacturer's guidelines for cleaning your shotgun. Make sure the tools you use do not invalidate the manufacturer's warranty or conflict with the manufacturer's recommendations.

The shotgun cleaning kit could include a bore brush, patches, lubricant, Bore Snake®, cleaning rod, gun solvent, and a cloth.

**Cleaning Tools**—Cleaning tools are gauge specific. Use the tools designated for the specific gauge of your weapon. A larger gauge cleaning brush or patch tip does not fit into a smaller one and may cause damage. A

smaller tool may not completely clean a larger firearm.

**Solvent and Lubricant**—Several types and brands of cleaners and solvents are available. Use solvent and lubricant specifically designed for firearms maintenance.

**Patches and Swabs**—Consider the weapon bore when choosing patches. Different materials have different absorption qualities. Follow the manufacturer's recommendations.

### Cleaning and Lubricating the Shotgun

To remove all lead, powder, debris, and dirt from the shotgun:

1. Take the barrel off the weapon, if possible.
2. With a bore brush and cleaning rod, clean and brush the bore and chamber of the barrel. Repeatedly push the bore brush completely through the barrel until it appears at the opposite end.
3. Use a non-metallic brush with solvent to clean areas contaminated with powder residue.
4. Use a patch, cleaning rod, and solvent to clean the bore, replacing the patch as needed.
5. Run a clean patch through the barrel to remove excess solvent and dirt. Repeatedly push the patch through the barrel until it appears at the opposite end.
6. Clean every part of the shotgun, and wipe the parts dry with a clean patch.

7. Lightly lubricate all parts including the bore of the barrel. Too much lubricant may damage a shotgun. Lubricant acts as a magnet, attracting dirt, dust, packing debris, and unburned powder.

When you finish cleaning and lubricating your shotgun:

1. Reassemble the shotgun.
2. Perform a function check of the shotgun.
3. Return the shotgun to safe storage, or securely re-case it.
4. Properly dispose of all cleaning supplies.
5. Wash your hands with soap and water.

**UNIT 9: WEAPONS CLEANING****LESSON 4 | SEMIAUTOMATIC RIFLE/CARBINE CLEANING****OBJECTIVES**

- ❖ Field strip the semiautomatic rifle/carbine based on make and model of weapon.
- ❖ Identify the proper supplies/ tools to use when cleaning the semiautomatic rifle/carbine.
- ❖ Clean the semiautomatic rifle/carbine, removing all lead, powder, debris, and dirt.
- ❖ Lubricate the semiautomatic rifle/carbine using lubricant and cloth/patches.
- ❖ Reassemble the cleaned semiautomatic rifle/carbine dependent upon the make and model of weapon.
- ❖ Function check the clean, reassembled semiautomatic rifle/carbine.
- ❖ Return the cleaned semiautomatic rifle/carbine to safe storage and/or securely re-case the weapon.
- ❖ Appropriately dispose of all debris and contaminated/used cleaning supplies.
- ❖ Wash your hands after cleaning a semiautomatic rifle/carbine.

**LESSON GOAL:** At the end of this lesson, you will understand the steps to cleaning and lubricating a semiautomatic rifle/carbine, and the necessary supplies and tools.

While field stripping and cleaning your rifle/carbine, remember these important points:

1. Safety check the weapon.
2. Remove live ammunition from the cleaning area.
3. Remove the magazine and secure it away from the weapon.
4. Verify that the chamber or magazine contains no ammunition.
5. Ensure the bolt is locked to the rear and the ejection port is open.

It is recommended that you observe manufacturer's guidelines for cleaning your semiautomatic rifle/carbine. Make sure the tools you use do not invalidate the manufacturer's warranty or conflict with the manufacturer's recommendations.

**Equipment**—A rifle/carbine cleaning kit could include swabs, a cleaning rod, lubricant(s), Bore Snake®, bore brush, cleaning solvent (non-penetrating), and cloth/patches.

**Cleaning Tools**—Cleaning tools are caliber specific. Use the tools designated for the specific caliber of your weapon. A larger caliber cleaning brush or patch tip does not fit into—and may damage—a smaller weapon. A small tool may not completely clean a large firearm.

**Solvent and Lubricant**—Several types and brands of cleaners and solvents are available. Use solvent and lubricant specifically designed for firearms maintenance.

**Patches and Swabs**—Consider the weapon bore when choosing patches. Different materials have different absorption qualities.

**Cleaning and Lubricating the Rifle/Carbine**

To remove all lead, powder, debris, and dirt from the rifle/carbine:

1. With a bore brush and cleaning rod, clean and brush the bore and chamber of the barrel from the chamber end. Repeatedly push the bore brush completely through the barrel until it appears at the opposite end.
2. Use a non-metallic brush with solvent to clean areas contaminated with powder residue.
3. Use a patch, cleaning rod, and cleaning solvent to clean the bore, replacing the patch as

needed.

4. Run a clean patch through the barrel from the chamber end to remove solvent and dirt. Repeatedly push the patch through the barrel until it appears at the opposite end.
5. Clean every part of the rifle/carbine and wipe the exterior parts dry with a clean patch.
6. Lightly lubricate all parts and the bore.

### **Cleaning the Magazine**

1. Field strip the magazine and clean all parts with a patch and solvent.
2. Wipe parts with a clean patch upon completion.
3. Wipe the exterior parts of the magazine with a lightly lubricated cloth or patch.
4. Clean the inside of the magazine with a dry cloth or patch.
5. Make sure the inside of the magazine is entirely dry.

When you finish cleaning and lubricating your semiautomatic rifle/carbine:

1. Reassemble the firearm.
2. Function check the firearm to ensure that all parts operate. Ensure that the bolt moves freely and spring tension is good, the safety works in both the on and off positions, the magazine feeds into the magazine well and releases freely, and that all metal parts are clean and lightly coated with lubricant or oil, except for the inside of the magazine(s).
3. Return the rifle/carbine to safe storage, or securely re-case it.
4. Properly dispose of all cleaning supplies.
5. Wash your hands with soap and water.

## UNIT 10: SURVIVAL SHOOTING

### LESSON 1 | HANDGUN

#### OBJECTIVES

- ❖ Disengage the holster retention device(s) with the support hand.
- ❖ Unload the handgun using one hand.
- ❖ Load a handgun using one hand.

**LESSON GOAL:** At the end of this lesson, you will be able to demonstrate drawing with the support hand, loading/reloading, and firing with one hand only.

#### Drawing: Support Hand Only

To draw your handgun using your support hand, do the following:

1. Reach across the front or back of your body, and use the fingers of your support hand to find the retention device(s) for your holster.
2. With the fingers of your support hand, disengage the retention device(s).
3. Grip the handgun.
4. Safely draw the handgun from its holster.
5. Safely bring the handgun across your body, watching the muzzle and ensuring your finger is outside the trigger guard, and point it at the target.

#### Reload Handgun with One Hand Only

Although reloading your handgun with two hands is preferable, some circumstances dictate that you reload with only one hand.

#### Unload/Reload a Revolver Using the Right Hand

To unload a revolver using only your right hand, do the following:

1. Establish a firm grip on your revolver with your right hand, while keeping the muzzle pointed in a safe direction and keeping your finger off the trigger.
2. Maintaining control of your revolver, open the cylinder. Use the technique appropriate for the model of your revolver.
3. Push the cylinder open with your index finger.
4. Place your thumb through the opening in the frame, under the top strap and over the cylinder.
5. Point the muzzle straight up.
6. Depress the extractor rod with your index finger, and extract empty shell casings from the cylinder.

To reload a revolver using only your right hand, do the following:

1. Place the grip of the weapon against your stomach.
2. Grab the top strap with the fingers of your right hand.
3. Place the barrel behind the gun belt inside the front of your pants with its cylinder facing out.
4. With your right hand, remove a speed loader from the pouch and insert the cartridges into the cylinder.
5. Hold the front of the cylinder with your little and ring fingers.
6. Apply pressure on the cylinder to hold it in place.
7. With your thumb and forefinger, turn the knob on the speed loader to release the cartridges.
8. Grip the revolver with the “shooting grip,” removing it from your waistband.
9. Close the cylinder using your right thumb.

### **Unload/Reload the Revolver Using the Left Hand**

To unload a revolver using only your left hand, do the following:

1. Grip the revolver firmly with your left hand, keep the muzzle pointed in a safe direction, and keep your finger off the trigger.
2. Maintaining control of your revolver, open the cylinder. Use the technique appropriate for the model of your revolver.
3. Open the cylinder by tapping the side of the cylinder against your holster.
4. Place your thumb on the top strap and your little finger over the hammer.
5. Move your thumb inside the frame, and put your index finger on the extractor rod.
6. Point the muzzle straight up.
7. Depress the extractor rod with your thumb or index finger, and remove empty shell casings from the cylinder.

To reload a revolver using only your left hand, do the following:

1. Place the barrel behind the gun belt inside the front of your pants with its cylinder facing out.
2. With your support hand remove the speed loader from the pouch and insert the cartridges into the cylinder.
3. Use your index, center, and ring fingers to control the cylinder, before releasing the cartridges.
4. With the thumb and index finger, turn the knob on the speed loader to release the cartridges.
5. Establish a firm shooting grip on your revolver, and remove it from your waistband.
6. Close the cylinder with your trigger finger.



## UNIT 10: SURVIVAL SHOOTING

### LESSON 2 | DISCRETIONARY SHOOTING

#### OBJECTIVES

- ❖ Scan surroundings for possible threats.
- ❖ Identify various methods of moving to cover and/or concealment.

**LESSON GOAL:** At the end of this lesson, you will be able to demonstrate the ability to identify and differentiate between threats, scan the environment, use proper movement/techniques to locate and move to a position of cover, and engage the proper threat(s).

Class “G” licensees must be able to identify deadly threats to themselves or others and then respond using only the amount of force necessary. If a threat demands deadly force, a Class “G” licensee must be able to identify that threat, innocent bystanders, field of fire, and what lies

beyond the field of fire; determine if cover is available; decide that deadly force is the only course of action; and respond as quickly as possible. A Class “G” licensee must use all of his or her faculties to make the right decision.

#### Threat Assessment

Upon arriving at the scene, scan the area for possible problems, including additional threats. The ability to assess a situation or subject depends largely on your observation skills, including the ability to recognize hazardous areas and potential weapons and identify areas that provide cover and/or concealment.

Your senses of sight, sound, smell, and touch increase your awareness of your surroundings. As you become more familiar with the normal conditions of those surroundings, you will also be more aware of and able to identify people, occurrences, and conditions that are out of place.

#### Movement

After you identify the threat, you may need to move to cover. To move effectively during an armed confrontation, you must be aware of many factors and be able to use different types of movement. Appropriate cover is any object big enough to hide your body, and strong enough to stop bullets. As you move from cover to cover, you must move quickly, safely, and without hesitation. You must be aware of your surroundings and of the condition of your weapon (loaded rounds available, etc.).

You must also know what suffices for cover, decide where to move, know if the location you choose allows you to see the area where the threat originates, and know when to move. Basic movement techniques and tactics follow, but they are not the only methods Class “G” licensees use. Always be open to new ideas and tactics that may give you options to help you survive.

#### Lateral Slide-Step Movement (Crab Walk)

1. Stand square to the target with your legs apart and your body balanced.
2. Shift your weight to the balls of your feet to allow movement. Be careful not to cross your feet.
3. Keep your back straight and your knees slightly bent.
4. Hold your firearm in a tactical ready stance.
5. Upon the direction to move, lead with the foot in that direction. For example, if you are going right, move your right foot first.
6. Keep your feet low to the ground, feeling for objects that may cause you to trip or block your movement. Stepping low also helps with balance.

7. Look toward the area of threat.

### **Discretionary Shooting Skills**

- ❖ Threat Recognition—The ability to distinguish a deadly threat from a non-deadly threat. You must take some type of appropriate action to neutralize a deadly threat, for example, firing a round at the target.
- ❖ Reaction Time—This is the time you take to distinguish a deadly threat from a non-deadly threat and then take appropriate action.
- ❖ Verbal Commands—Use these to identify yourself and direct the subject. Give loud, clear, and concise commands, saying, for example, “Stop! Don’t move!”
- ❖ Reloading—Take proper cover and reload. Use of Cover—Move to cover.
- ❖ Weapon Status—Follow all safety rules when handling the weapon. Show awareness of the weapon’s status, and respond to weapon malfunctions.
- ❖ Engagement of Non-deadly Threat—Identify the non-deadly threat and respond with proper verbal commands.
- ❖ Neutralized Target—Neutralize all deadly threats.

## **APPENDICES**

**APPENDIX A: Courses of Fire****QUALIFICATION  
COURSE OF FIRE****HANDGUN QUALIFICATION**

**LESSON GOAL:** In this lesson, students will fire the approved course of fire specified in this manual to reflect acquisition of minimum training criteria.

**NOTICE:** *In the event that qualification or requalification concludes before the prescribed hour(s), the instructor is to use this time for furtherance of practical exercises and/or ACTUAL cleaning of firearms.*

**Text/Materials/Instructional Aids**

- ❖ Firearms Training Manual – Student Handbook and Study Guide
- ❖ Instructor Material: Handgun Qualification Course of Fire

**Performance Objective**

After completion of classroom training and live fire exercises, shoot qualifying score on the qualification course of fire.

**Required Activities**

- ❖ Lead students through the Handgun Qualification Course
- ❖ A student shall fire the stages on the approved course of fire in sequential order beginning with Stage 1 until all stages are complete.

**Description of Course of Fire**

- ❖ The QUALIFICATION COURSE FOR INITIAL LICENSURE shall consist of three cycles of 48 rounds each for a total of 144 rounds to be fired (one practice round and two qualification rounds).
- ❖ The REQUALIFICATION COURSE FOR RENEWAL LICENSURE shall consist of three cycles of 48 rounds each for a total of 144 rounds to be fired. However, requalification can be concluded upon the student's firing a passing score upon any one of the three cycles.
- ❖ A passing score is a minimum of 70% or 168 out of a possible 240 points. Targets will be scored as follows:
  - 5 points for any hit on, inside, or touching the 8 ring;
  - 4 points for any hit on or touching the 7 ring;
  - 3 points for any hit outside of the scoring rings but still on or touching the silhouette.

<b>HANDGUN QUALIFICATION AND REQUALIFICATION</b> <b>COURSE OF FIRE</b> <b>Entire Qualification/Requalification is completed with two B-34 targets or B-29 reduced targets</b>	
<b>Stage 1: Two-Handed High Point</b> <b>From Holster - 3 yd</b>	<b>Stage 2: High Point</b> <b>From High-Ready - 3 yd</b>
<ul style="list-style-type: none"> <li>• 1 round on <b>R/TGT</b> 1 round on <b>L/TGT</b> in 4 seconds</li> <li>• 1 round on <b>L/TGT</b> 1 round on <b>R/TGT</b> in 4 seconds</li> <li>• 1 round on <b>L/TGT</b> 1 round on <b>R/TGT</b> in 4 seconds</li> </ul> <p style="text-align: center;">MANDATORY RELOAD</p> <p style="text-align: center;"><b>TOTAL: 6 ROUNDS</b></p>	<ul style="list-style-type: none"> <li>• 3 rounds on <b>R/TGT</b> in 3 seconds (Two-Handed)</li> <li>• 3 rounds on <b>L/TGT</b> in 3 seconds (Two-Hand)</li> </ul> <p style="text-align: center;">MANDATORY RELOAD</p> <ul style="list-style-type: none"> <li>• 3 rounds on <b>L/TGT</b> using <b><u>strong hand ONLY</u></b> in 20 seconds</li> <li>• 3 rounds on <b>R/TGT</b> using <b><u>support hand ONLY</u></b> in 20 seconds</li> </ul> <p style="text-align: center;"><b>TOTAL: 12 ROUNDS</b></p>
<b>Stage 3: Two-Handed High Point</b> <b>From Holster - 7 yd</b>	<b>Stage 4: Two-Handed High Point</b> <b>From Holster - 7 yd</b>
<ul style="list-style-type: none"> <li>• 3 rounds on <b>R/TGT</b> in 5 seconds</li> </ul> <p style="text-align: center;">MANDATORY RELOAD</p> <ul style="list-style-type: none"> <li>• 3 rounds on <b>L/TGT</b> in 5 seconds</li> </ul> <p style="text-align: center;"><b>TOTAL: 6 ROUNDS</b></p>	<ul style="list-style-type: none"> <li>• 1 round on <b>R/TGT</b>, 1 round on <b>L/TGT</b> in 7 seconds</li> <li>• 1 round on <b>L/TGT</b>, 1 round on <b>R/TGT</b> in 7 seconds</li> <li>• 1 round on <b>R/TGT</b>, 1 round on <b>L/TGT</b> in 7 seconds</li> </ul> <p style="text-align: center;"><b>TOTAL: 6 ROUNDS</b></p>
<b>Stage 5: Two-Handed High Point</b> <b>From Holster - 15 yd</b>	<b>Stage 6: Two-Handed High Point</b> <b>From Holster - 15 yd</b>
<ul style="list-style-type: none"> <li>• 6 rounds on <b>R/TGT</b> in 40 seconds</li> </ul> <p style="text-align: center;">MANDATORY RELOAD</p> <ul style="list-style-type: none"> <li>• 6 rounds on <b>L/TGT</b> in 40 seconds</li> </ul> <p style="text-align: center;"><b>TOTAL: 12 ROUNDS</b></p>	<ul style="list-style-type: none"> <li>• 2 rounds on <b>L/TGT</b> in 10 seconds</li> <li>• 2 rounds on <b>R/TGT</b> in 10 seconds</li> <li>• 2 rounds on <b>L/TGT</b> in 10 seconds</li> </ul> <p style="text-align: center;"><b>TOTAL: 6 ROUNDS</b></p>

## **Stage I**

**Objective:** To develop techniques of the quick draw, weapon alignment, multiple target engagements, and close quarters target engagement.

3 yard line, 6 rounds, 4 seconds per string

### **Procedure:**

1. Firearm loaded, securely holstered.
2. On command, draw and assume two-handed high point position and fire one (1) round on right side target and one round on left side target in 4 seconds.
3. Continue to cover down on target.
4. On command, return firearm to holster.
5. On command, repeat two more times (alternating which target is to be shot first) for a total of six (6) rounds. On final string, reload and continue to cover target.

#### **POINT OF CLARIFICATION: For the mandatory reload in the handgun qualification course (both initial and requalification)**

During the firing of all handgun qualification courses, mandatory reloads will be accomplished by performing a standard “two- handed” reload. There are to be no “one-hand” reload procedures used during live fire events. Those procedures, as provided in Unit10 (Survival Shooting) of the Firearms Training Manual are for informational purposes only.

6. On command make weapon safe and securely holster.

## **Stage II**

**Objective:** To continue development of quick weapon alignment, as well as support hand only technique.

3 yard line, 12 rounds, 3 seconds for 1<sup>st</sup> & 2<sup>nd</sup> string, 20 seconds for 3<sup>rd</sup> & 4<sup>th</sup>

### **Procedure:**

1. Firearm loaded, in high-ready position.
2. On command, bring firearm to high point position and fire three (3) rounds on right side target in 3 seconds. Continue to cover down on target.
3. On command, return firearm to high-ready position.
4. On command, bring firearm to high point position and fire three (3) rounds on left side target in 3 seconds.

#### **POINT OF CLARIFICATION: For the mandatory reload in the handgun qualification course (both initial and requalification)**

During the firing of all handgun qualification courses, mandatory reloads will be accomplished by performing a standard “two- handed” reload. There are to be no “one-hand” reload procedures used during live fire events. Those procedures, as provided in Unit10 (Survival Shooting) of the Firearms Training Manual are for informational purposes only.

5. On command, return firearm to high-ready. Hold firearm strong hand only, on command bring to high point and fire three (3) rounds on left target in 20 seconds.
6. On command move firearm to support hand.

7. On command bring firearm to one-handed high point and fire three (3) rounds using support hand only in 20 seconds. Reload, continue to cover target.
8. On command make weapon safe and securely holster.

### **Stage III**

**Objective:** To develop the technique of drawing the handgun from the holster with maximum safety, speed, and accuracy.

7 yard line, 6 rounds, 5 seconds per string

#### **Procedure:**

1. On command, load and securely holster firearm.
2. On command, draw and assume two-handed high point position, fire three (3) rounds on right side target in 5 seconds.
3. Continue to cover target.
4. On command, complete mandatory reload.

**POINT OF CLARIFICATION: For the mandatory reload in the handgun qualification course (both initial and requalification)**

During the firing of all handgun qualification courses, mandatory reloads will be accomplished by performing a standard “two- handed” reload. There are to be no “one-hand” reload procedures used during live fire events. Those procedures, as provided in Unit10 (Survival Shooting) of the Firearms Training Manual are for informational purposes only.

5. On command, draw and assume two-handed high point position, fire three (3) rounds on left side target in 5 seconds. Reload, continue to cover target.
6. On command make weapon safe and securely holster.

### **Stage IV**

**Objective:** To develop techniques of quick and accurate weapon alignment.

7 yard line, 6 rounds, 7 seconds per string.

#### **Procedure:**

1. Firearm loaded, securely holstered.
2. On command, bring firearm to two-handed high point position, fire one (1) round on right side target and one (1) round on left side target in 7 seconds. Continue to cover down on target.
3. On command, return firearm to holster. Repeat for a total of six (6) rounds (alternating which target is shot first). On final string, reload and continue to cover target.
4. On command make weapon safe and securely holster.

## Stage V

**Objective:** To develop technique necessary to reload and sustain fire.

15 yard line, 12 rounds, 45 seconds

### **Procedure:**

1. Firearm loaded, securely in holster.
2. On command, bring firearm to two-handed high point position, fire six (6) rounds on right side target, reload, fire six (6) rounds on left side target in 40 seconds. Reload, continue to cover target.

**POINT OF CLARIFICATION: For the mandatory reload in the handgun qualification course (both initial and requalification)**

During the firing of all handgun qualification courses, mandatory reloads will be accomplished by performing a standard “two- handed” reload. There are to be no “one-hand” reload procedures used during live fire events. Those procedures, as provided in Unit10 (Survival Shooting) of the Firearms Training Manual are for informational purposes only.

3. On command make weapon safe and securely holster.

## Stage VI

**Objective:** To develop the technique of quick and accurate weapon alignment at distance.

15 yard line, 6 rounds, 10 seconds per string

### **Procedure:**

1. Firearm loaded, securely in holster.
2. On command, bring firearm to two-handed high point position, fire two (2) rounds on left side target in 10 seconds. Continue to cover down on target.
3. On command, return firearm to holster.
4. On command, bring firearm to two-handed high point position, fire two (2) rounds on right side target in 10 seconds. Continue to cover down on target.
5. On command, return firearm to holster.
6. On command, bring firearm to two-handed high point position, fire two (2) rounds on left side target in 10 seconds. - (B Stage completed with an empty firearm.)

After students complete the 48-round course of fire, safety-check their weapons to make sure they are unloaded. Students should then holster unloaded weapons.



**SCORE TARGETS**

On all courses of fire, any diameter hit inside the scoring area or any partial diameter hit that breaks the line of the approved scoring area will add to a student's score. Ancillary paper tears should not be counted when scoring.

- ❖ Only certified firearms instructors will score targets.
- ❖ Any hit on or touching the silhouette adds to the student's score.
- ❖ To successfully demonstrate handgun proficiency, a student must score, at minimum, 168 out of a possible 240 points (70%), using the scoring method detailed in the Description of Course of Fire.
- ❖ A student who does not comply with the requirements cannot qualify. Reasons for disqualification may include improperly drawing the weapon or firing too many rounds at either target. When a student completes this course, he or she should have fired 69 rounds on the right target, and 75 rounds on the left target

If the ammunition or weapon malfunctions, the instructor determines if the student may fire an alibi round. If so, the student must fire that alibi round under conditions prevailing in that stage of fire.

## QUALIFICATION COURSE OF FIRE

### Shotgun Qualification

**LESSON GOAL:** In this lesson, students will fire the approved course of fire specified in this manual to reflect acquisition of minimum training criteria.

**NOTICE:** *In the event that qualification or requalification concludes before the prescribed hour(s), the instructor is to use this time for furtherance of practical exercises and/or ACTUAL cleaning of firearms.*

#### Text/Materials/Instructional Aids

- ❖ Firearms Training Manual – Student Handbook and Study Guide
- ❖ Instructor Material: Shotgun Qualification Course of Fire

#### Performance Objective

After completing the firearms classroom training and live fire exercises, shoot a qualifying score on the state shotgun qualification course of fire.

#### Required Activities

- ❖ Lead students through the Shotgun Qualification Course.
- ❖ A student shall fire the stages on the approved course of fire in sequential order beginning with Stage 1 until all stages are complete.

#### Description of Course of Fire

- ❖ For proper scoring of this qualifications/requalification exercise, student must shoot #00 buck containing 9 pellets.
- ❖ The QUALIFICATION COURSE will be shot three (3) complete cycles with eight (8) rounds being fired per cycle for a total of 24 rounds (one practice cycle and two qualification cycles).
- ❖ The REQUALIFICATION COURSE can be shot a maximum of 3 times for a total of 24 rounds. However, requalification can be concluded as soon as a passing score is achieved.

<b>COURSE OF FIRE FOR CLASS "G" SHOTGUN QUALIFICATION AND REQUALIFICATION</b>	
<b>Entire Qualification/Requalification is completed with two (2) B-34 Targets <u>ONLY</u></b>	
<b>Stage 1: Standing Ready 15yd</b>	<b>Stage 2: Shoulder Position From Cover 15yd</b>
<ul style="list-style-type: none"> <li>• 1 round on <b>R/TGT</b> 5 seconds</li> <li>• 1 round on <b>L/TGT</b> 3 seconds</li> <li>• 1 round on <b>R/TGT</b>, 1 round on <b>L/TGT</b> 5 seconds</li> </ul> <p style="text-align: center;"><b>TOTAL: 4 ROUNDS</b></p>	<ul style="list-style-type: none"> <li>• 1 round on <b>R/TGT</b> 7 seconds</li> <li>• 1 round on <b>L/TGT</b> 4 seconds</li> <li>• 1 round on <b>R/TGT</b>, 1 round on <b>L/TGT</b> in 7 seconds</li> </ul> <p style="text-align: center;"><b>TOTAL: 4 ROUNDS</b></p>

**Stage I**

**Objective:** To develop techniques to be used in going from standing READY position to the SHOULDER position, with proper target alignment consistent with maximum safety and proficiency at medium range.

15 yard line, (4) rounds, 3 strings, varying times

**Procedure:** Shotgun magazine loaded with (4) rounds, slide action forward, safety on.

## ❖ String 1

1. On command, from the STANDING READY position, depress the action bar release, chamber (1) round, assume the SHOULDER position.
2. Move safety to "OFF", fire (1) round on right target in 5 seconds, eject spent shell and chamber live round. Continue to cover target.
3. Upon command, return to STANDING READY position.

## ❖ String 2

1. On command, assume SHOULDER position, fire (1) round on left target in 3 seconds, eject spent shell and chamber live round. Continue to cover target.
2. Upon command, return to STANDING READY POSITION.

## ❖ String 3

1. On command, assume SHOULDER position, fire (1) round on right target and (1) round on left target for total of (2) rounds in 5 seconds.
2. Upon command, safety check shotgun.

## Stage II

**Objective:** To develop techniques to be used in going from the standing READY position to the SHOULDER position, with proper target alignment consistent with maximum safety with the use of cover at medium range.

15 Yard line, (4) rounds, 3 strings, varying times

**Procedure:** Shotgun magazine loaded with (4) rounds, slide action forward, safety on.

❖ String 1

1. On command, from the STANDING READY position, move to cover, depress the action bar release, chamber (1) round, assume the SHOULDER position.
2. Move safety to "OFF", fire (1) round on right target in 7 seconds, eject spent shell and chamber live round. Continue to cover target.
3. Upon command, return to STANDING READY position.

❖ String 2

1. On command, move to cover, assume SHOULDER position, fire (1) round on left target in 4 seconds, eject spent shell and chamber live round. Continue to cover target.
2. Upon command, return to STANDING READY position.

❖ String 3

1. On command, move to cover, assume SHOULDER position, fire (1) round on right target and (1) round on left target for total of (2) rounds in 7 seconds.
2. Upon command, safety check shotgun.

## SCORE TARGETS

Total of (8) rounds:

- ❖ Any hit on the approved target (B-34 color optional) shall be scored when shooting buckshot.
- ❖ Only licensed Class "K" Firearms Instructors shall score targets.
- ❖ Students must attain a minimum of 70% (50 hits of 72) of the total hits using buckshot.
- ❖ The (re)qualification course shall consist of 3 cycles of 8 rounds each for a total of 24 rounds to be fired. However, (re)qualification can be concluded upon the student's firing a passing score upon any one of the three cycles.

## Qualification Course of Fire

### Semiautomatic Rifle/Carbine (Re)qualification

**LESSON GOAL:** In this lesson, students will fire the approved course of fire specified in this manual to reflect acquisition of minimum training criteria.

**NOTICE:** *In the event that qualification or requalification concludes before the prescribed hour(s), the instructor is to use this time for furtherance of practical exercises and/or ACTUAL cleaning of firearms.*

#### Performance Objectives

After completing the firearms classroom training and live fire exercises, shoot a qualifying score on the state semiautomatic rifle/carbine qualification course of fire.

#### Text/Materials/Instructional Aids

- ❖ Firearms Training Manual – Student Handbook and Study Guide
- ❖ Instructor Material: Rifle Qualification Course of Fire

#### Instructor Note

- ❖ Some shooters have a tendency to allow the barrel of the rifle to be pointed at their feet when removing and inserting the magazine. Ensure that safety standards are maintained.
- ❖ The instructor shall ensure that all students know what is expected of them on the firing line and can function in a safe manner. If there is any doubt, or if any shooter demonstrates they cannot or will not function within the safety behavioral standards, they shall be removed from the range. Written documentation surrounding the event will then be prepared and maintained by the instructor.

#### Required Activities

- ❖ Lead students through the Rifle Qualification Course
- ❖ A student shall fire the stages on the approved course of fire in sequential order beginning with Stage 1 until all stages are complete.

#### Description of Course of Fire

Before beginning the course and with all shooters from the 25-yard line:

1. Fill two magazines with 15 rounds of ammunition.
2. Upon command, with your empty rifles/carbines in safe mode, insert a magazine, load a round into the chamber, and take a low-ready position.

**PATROL RIFLE QUALIFICATION AND REQUALIFICATION COURSE**

The QUALIFICATION COURSE will be shot 3 times for a total of 90 rounds to be fired (one practice round and two qualification rounds).

The REQUALIFICATION COURSE can be shot a maximum of 3 times for a total of 90 rounds.

**However, requalification can be concluded as soon as a passing score is achieved.**

<b>COURSE OF FIRE FOR CLASS "G" PATROL RIFLE QUALIFICATION AND REQUALIFICATION</b>	
Entire Qualification/Requalification is to be completed with two (2) B-29 reduced targets. <u>Distances shown are reduced distances to be shot with the B-29 target only.</u>	
<b>Stage 1: Shoulder Ready 75 feet</b>	<b>Stage 2: Shoulder Ready From Cover 50 ft</b>
<ul style="list-style-type: none"> <li>• 3 rounds kneeling on <b>L/TGT</b> in 20 seconds</li> <li>• 3 rounds prone on <b>R/TGT</b> in 20 seconds</li> </ul> <p style="text-align: center;"><b>TOTAL: 6 ROUNDS</b></p>	<ul style="list-style-type: none"> <li>• 3 rounds on <b>R/TGT</b> in 10 seconds</li> <li>• 3 rounds on <b>L/TGT</b> in 10 seconds</li> </ul> <p style="text-align: center;"><b>TOTAL: 6 ROUNDS</b></p>
<b>Stage 3 Shoulder Ready 30 ft</b>	<b>Stage 4 Shoulder Ready 14 ft</b>
<ul style="list-style-type: none"> <li>• 3 rounds standing on <b>L/TGT</b></li> <li>• 3 rounds kneeling on <b>R/TGT</b> in 15 seconds</li> </ul> <p style="text-align: center;"><b>TOTAL: 6 ROUNDS</b></p>	<ul style="list-style-type: none"> <li>• 6 rounds on <b>R/TGT</b>, Reload</li> <li>• 6 rounds on <b>L/TGT</b> in 20 seconds</li> </ul> <p style="text-align: center;"><b>TOTAL: 12 ROUNDS</b></p>

A passing score is a minimum of 70% or 105 out of a possible 150 points. Targets will be scored as follows:

- ❖ 5 points for any hit on, inside, or touching the 8 ring;
- ❖ 4 points for any hit on or touching the 7 ring;
- ❖ 3 points for any hit outside of the scoring rings but still on or touching the silhouette.

### **Stage I**

**Objective:** To develop the 7 fundamentals of marksmanship

75 ft line, 6 rounds, 20 seconds per string

#### **Procedure:**

1. Firearm loaded, in the low ready position with safety engaged.
2. On command, assume kneeling position with rifle shouldered. Fire three (3) rounds on left side target in 20 seconds. Continue to cover down on target.
3. On command, fire three (3) rounds on right side target in 20 seconds, reload and continue to cover target.
4. On command make weapon safe and secure.

### **Stage II**

**Objective:** To continue development of the fundamentals of marksmanship

50 ft line, 6 rounds, 10 seconds per string

#### **Procedure:**

1. Firearm loaded, in the low ready position with safety engaged.
2. On command, bring firearm to shoulder ready position and fire three (3) rounds on right side target in 10 seconds. Continue to cover down on target.
3. On command, return firearm to shoulder ready position and fire three (3) rounds on left side target in 10 seconds. Reload and continue to cover target.
4. On command make weapon safe and secure.

### **Stage III**

**Objective:** To develop the technique of quick target acquisition and sight alignment and to gain experience transitioning from a standing to a kneeling position

30 ft line, 6 rounds, 15 seconds

#### **Procedure:**

1. Firearm loaded, in the low ready position with safety engaged.
2. On command, bring firearm to shoulder ready position and fire three (3) rounds on left side target, enter kneeling position, fire three (3) rounds on right side target in 15 seconds.
3. On command, reload and continue to cover target.
4. On command make weapon safe and secure.

**Stage IV**

**Objective:** To develop techniques of quick and accurate weapon alignment as well as gaining experience with speed reloads

14 ft line, 12 rounds, 20 seconds

**Procedure:**

1. Firearm loaded, in the low ready position with safety engaged.
2. On command, bring firearm to shoulder ready position and fire six (6) rounds on right side target, speed reload, fire six (6) rounds on left side target in 20 seconds.
3. On command, show empty and put firearm on safe.

**SCORE TARGETS**

On all courses of fire, any diameter hit inside the scoring area or any partial diameter hit that breaks the line of the approved scoring area will add to a student's score. Ancillary paper tears should not be counted when scoring.

- ❖ Only certified firearms instructors will score targets.
- ❖ Any hit inside or touching the exterior scoring line of the approved target adds to a student's score.
- ❖ The projectile must touch the exterior scoring line. Do not count ancillary paper tears.
- ❖ The approved targets include the Q-RD or Q-TCRD2 reduced targets or the B-29 (reduced police silhouette).
- ❖ Students must hit the scoring area at least 21 times out of 30 fired rounds.
- ❖ The (re)qualification course shall consist of 3 cycles of 30 rounds each for a total of 90 rounds to be fired. However, (re)qualification can be concluded upon the student's firing a passing score upon any one of the three cycles



**APPENDIX B: SHOOTING TARGETS**

The approved targets for this course are the B-34 and the reduced size B-29 targets. The following is an example of the B-34/B-29 target:

Distances provided in the qualification sections of this manual (**unless otherwise noted**) represent that of which the B-34 targets will be shot. Reduced ranges are to use the B-29 target at the following distances:

B-29 Reduced Target Distances						
Firearm	Stage 1	Stage 2	Stage 3	Stage 4	Stage 5	Stage 6
<b>Handgun</b>	2 yards (6 feet)	2 yards (6 feet)	4 yards 2 feet (14 feet)	4 yards 2 feet (14 feet)	10 yards (30 feet)	10 yards (30 feet)
<b>Rifle</b>	25 yards (75 feet)	16 yards 2 feet (50 feet)	10 yards (30 feet)	4 yards 2 feet (14 feet)		



## APPENDIX C: CASE STUDY ANSWERS

### Case Study #1

You are an armed security officer working the parking lot area at a sporting event. Two groups of rival fans get involved in a verbal argument. This verbal argument escalates when two of the rival fans get into a physical shoving match. The crowd seems to be egging on these two unarmed individuals. The larger of the combatants appears to be getting the better of the other and you can see the larger man's hands up around the neck area of the other, who appears to be in some distress and unable to breathe as a result of the incident. You push the larger man away from the man in distress and become aware that the larger man appears intoxicated as he is wildly throwing uncoordinated punches in your direction. The crowd has kept its distance and the man that was in distress is no longer in the zone of danger from the larger man. Is deadly force justified?

**Answer:** Any use of deadly force at this point would have to be based on the officer's fear of death or great bodily harm from the larger man. It is possible that a forcible felony occurred when the larger man's hands were in the neck area of the man who appeared to be in distress, but once that attack was over and the man was removed from the zone of imminent danger, any right to use deadly force based on that purported forcible felony had passed. It is not likely that a court would find that the use of deadly force against the unarmed intoxicated man was justified. See *Mederos v. State*, 102 So.3d 7 (Fla. 1st DCA 2012). In this case the appellate court agreed with the lower court's determination that Mederos was not entitled to the dismissal of criminal charges for aggravated assault based on immunity under "stand your ground."

### Case Study #2

You are working as an armed body guard for a male client at a restaurant; the client is with several female colleagues. You escort the client outside where your client smokes a cigarette. Upon your return to the table two men are speaking with the female colleagues. Your client asks the men to leave and a heated verbal exchange ensues. Later in the evening you notice one of the two men looking toward you and your client with a "mean and cold look on his face." Your client decides that it is time to leave the restaurant but prior to leaving you escort him to the bathroom. On returning from the restroom to settle the bill you see the two men from earlier outside the restaurant banging aggressively on the restaurant's window and pointing towards you and your client. You wait approximately ten minutes and after it appears that the two men have left you escort your client out of the restaurant. While out in the parking lot your client stands by his car smoking. One of the two men from earlier in the evening runs up to your client striking him in the face with a clenched fist. You can see large amounts of blood coming from your client's face. The man throws his hands up in the air as if he is a prizefighter, then the man approaches you but stops. Then you notice the other man from earlier running towards you. As he nears you he, reaches under his baggy shirt. Is deadly force justified?

**Answer:** If you reasonably feel that the man running towards you is reaching for a weapon and you are in fear of death or great bodily harm then you may be justified in using deadly force. This scenario is based on *Mobley v. State*, 132 So.3d 1160 (Fla. 3d DCA 2014). In *Mobley* a divided three judge appellate panel overturned the circuit court's denial of immunity under "stand your ground" and found that *Mobley* a private citizen who lawfully possessed the firearm used was entitled to "stand your ground" immunity. The dissenting justice outlines many other factors in regard to the incident that could have turned the case against *Mobley*.

**Case Study #3**

You are an armed security officer at an apartment complex. A man approaches one of the units and begins banging on the door and yelling for the resident in a very loud and aggressive tone of voice. You are aware that the resident of that apartment is not home and ask the man to leave the premises. The man turns toward you and makes several verbal threats towards you to include getting his gang member friends to shoot the place up and to burn down the apartment complex. You again instruct the man to leave and he turns as if to leave only to suddenly run up to you and strike you on the face with a closed fist. Your knees buckle and blood comes down the side of your face. The man takes up position a few feet from you and pulls his shirt open and places his arms behind his back. The man tells you he has a “Glock” and is going to “cap” you as he comes toward you. Is deadly force justified?

**Answer:** If you reasonably feel that the man coming towards you is reaching for a weapon and you are in fear of death or great bodily harm then you may be justified in using deadly force. This scenario is based on *Jenkins v. State*, 942 So.2d 910 (Fla. 2d DCA 2006). Jenkins was a roofer on his way to work when he was confronted by an angry and threatening man banging on the door of his neighbor and wife’s residence. Jenkins, a convicted felon, possessed on his belt a six inch sheath knife. Numerous uninterested witnesses laid out the facts as to what happened. Jenkins who was convicted at trial of the lesser offense of manslaughter without a weapon was sentenced to twenty-five years in prison. The appellate court threw out his conviction based on an earlier version of section 776.012, Florida Statutes.

**Case Study #4**

You are an armed security officer working at a large department store when you are notified by radio that a man armed with a knife just robbed the jewelry counter and headed out the east exit. You exit the north side of the store and see a man matching the description of the suspect run to a waiting car and head in your direction. You wave at the car and feel as though the driver may hit you. You draw your weapon and as the car comes closer, you dive out of the way. Is deadly force justified?

**Answer:** Once the car has passed, the officer is no longer in reasonable fear of death or great bodily harm; there is no justification for the use of deadly force. This scenario is based on *Montanez v. State*, 24 So.3d 799 (Fla. 2d DCA 2010). In this case, Montanez shot through the side window of a passing car. Montanez claimed the victim was driving towards him. The trial court noted that when a car is being driven there is a “zone of uncertainty” as to where the car will or can go. Here the court found that Montanez had discharged his firearm after the zone of uncertainty had passed, and along with it any reasonable threat of death or great bodily harm. Montanez received a 35 year sentence for 3rd degree murder; he is scheduled for release in February 2047.

**Case Study #5**

This case study is based on the criminal prosecution of a security officer who shot into a moving vehicle injuring the driver. The security officer witnessed the driver run into a man with her vehicle. The security officer attempted to detain the driver and when the driver got back into her car and attempted to leave the following, as reported by eye witnesses, occurred.

Witness #1 reported that: he observed the security officer in the parking lot of the community center attempt to detain all persons in the initial altercation. The victim of the initial altercation told the driver that she could leave as the security officer was not a law enforcement officer. He then saw the driver get into her car and attempt to drive around the security officer. He then saw the security officer hanging onto the window of the vehicle as it was moving, the security officer asked the driver to stop the vehicle to which the driver refused. Finally, he saw the security officer let go of the window, draw his firearm and shoot five rounds into the front driver's side of the vehicle.

Witness #2 reported that: she saw the security officer, driver, and a man in the parking lot of the community center. She observed the man tell the driver that the security officer was not a law enforcement officer and she could leave. The driver got back into her vehicle and the security officer got in front of the vehicle and ordered the driver to stop. The driver then drove around the security officer and the security officer grabbed onto the driver's side window, ordering the driver to stop, she did not. Finally she saw the security officer fire 4-5 shots into the driver's side window as the car left the area.

Witness#3 reported that: she observed the security officer with the driver and the man. The security officer told the driver they could not leave until the police arrived. The driver got into her car and the security officer stood in front of the vehicle. The driver then drove around the security officer. She observed the security officer on the side of the vehicle and then fired 4 shots into the vehicle.

Witness #4 reported that: she observed the security officer attempt to detain the driver at the community center. The driver entered her vehicle and attempted to leave. The security officer removed his firearm and was standing in front of the vehicle. Then she saw the driver swerve around the security officer, at which point the security officer fired shots at the driver's side front and rear side of the vehicle.

**Answer:** In this case the use of deadly force was not found to be justified. The security officer testified at trial that he fired his weapon to protect himself after being run over by the vehicle's front tires. The jury convicted the security officer on one count of aggravated battery with a deadly weapon and one count of shooting or throwing a missile into a building or vehicle. The security officer is currently serving a prison sentence of 25 years and 15 years respectively for these crimes. His case is currently under appeal.

**Case Study #6**

This case study involves a security officer discharging his firearm at a vehicle in a public transit station. The security officer had instructed a motorist who had parked his vehicle in a no parking area to leave the area and park elsewhere. Video evidence showed the security officer position himself a few feet behind the vehicle. The security officer claimed that there was ample room for the driver to pull forward. The driver placed the vehicle in reverse and slowly backed into the security officer making contact with the security officer. The security officer drew his firearm and as the vehicle was driving away firing several rounds into the rear tire of the vehicle.

**Answer:** The use of deadly force was not justified in this case. The security officer was arrested and charged with battery and shooting onto an occupied vehicle. The security officer had adjudication withheld on the crime of discharging a firearm in public.

**Case Study #7**

You are a security officer working at a convenience store. You witness a patron get into an argument with the cashier over the return of some money. The patron starts picking items up off the counter and throwing them at the cashier. Then cashier also picks up items from the counter and throws them at the patron. You tell the patron to leave and the patron exits the store. On his way out of the store the patron states: "I'm going to go to my car and get my gun and blow your heads off, I'm going to kill all of you." You are positioned at the door of the store with the door to the store open where you can observe the patron in the parking lot. As the patron reaches his car you see the patron lift his untucked shirt and reach toward his waistband. Is the use of deadly force warranted?

**Answer:** No deadly force is likely not appropriate based on these facts. This scenario is based on *Odeh v. State*, 82 So.3d 915 (Fla. 4th DCA 2011). Here Odeh, a clerk at a convenience store was convicted of attempted 1st degree murder and sentenced to eight years in prison. The patron who was paralyzed did not possess a gun as he claimed and the court found that Odeh was not justified in using deadly force based on the facts of the case.

## Appendix D: Glossary

**Aggravated Assault:** an assault with a deadly weapon without intent to kill; OR with intent to commit a felony. See s. 784.021, FS.

**Aggravated Battery:** a battery where the person committing the battery: intentionally or knowingly causes great bodily harm, permanent disability or permanent disfigurement; OR uses a deadly weapon; OR the victim was pregnant and the offender knew or should have known that the victim was pregnant. See s. 784.045, FS.

**Assault:** an intentional, unlawful threat by word or act to do violence to the person of another coupled with an apparent ability to do so, and doing some act which creates a well-founded fear in such other person that such violence is imminent. See s. 784.011(1), FS. (Note: Simple assault is NOT a forcible felony)

**Battery:** occurs when a person actually and intentionally touches or strikes another person against the will of the other; OR intentionally causes bodily harm to another. See s. 784.03(1)(a), FS. (Note: Simple battery is NOT a forcible felony)

**Burglary:** the entering of a dwelling, structure, or conveyance with the intent to commit an offense therein, unless at the time the premises are at the time open to the public or the defendant is licensed or invited to enter, OR if having been previously invited or licensed to enter remains in the dwelling, structure, or conveyance, either surreptitiously or after permission to remain has been withdrawn, with intent to commit an offense, OR to commit or attempt to commit a forcible felony as defined in s. 776.08, FS. See s. 810.02 (1)(b), FS.

**Carjacking:** the taking of a motor vehicle from the person or custody of another with the intent to permanently or temporarily deprive the person or owner of the motor vehicle, and in doing so there is the use of force, violence, assault, or putting in fear. See s. 812.133(1), FS.

**Civil Liability:** occurs when a person is responsible for a civil wrong [or tort] to another.

**Concealment:** any object or group of objects that creates a visual barrier between you and a threat but may not stop a projectile.

**Cover:** any object or obstacle that creates a bullet-resistant barrier between you and a threat.

**Criminal Liability:** occurs when a person violates a criminal law contained in Florida Statutes.

**Double action only:** occurs when every round fires double action with the hammer at rest against the rear of the slide.

**Double feed:** a failure to extract the round in the chamber and a new round being fed from the magazine.

**Double/single pistol:** occurs when the first round fires double action and the second and subsequent rounds fire single action as the hammer remains cocked each time the slide cycles.

**Failure to eject (stovepipe):** occurs when a fired cartridge case does not completely eject.

**Failure to extract:** occurs when the pistol fails to extract a spent casing from its chamber.

**Failure to feed:** occurs when the cartridge fails to feed into the chamber.

**Failure to fire:** occurs when the trigger is pulled, but the round fails to detonate.

**Felony:** any crime committed for which the maximum penalty includes possible incarceration in a state prison for more than one year. See s. 775.08(1), FS.

**Forcible Felony:** treason; murder; manslaughter; sexual battery; carjacking; home-invasion robbery; robbery; burglary; arson; kidnapping; aggravated assault; aggravated battery; aggravated stalking; aircraft piracy; unlawful throwing, placing, or discharging of a destructive device or bomb; and any other felony which involves the use or threat of physical force or violence against any individual. See s. 776.08, FS.

**Frozen cylinder:** a cylinder that does not rotate.

**Handgun:** refers to either the revolver or the semiautomatic pistol.

**Kidnapping:** forcibly, secretly, or by threat confining, abducting, or imprisoning another person against his/her will with the intent to hold for ransom, reward or as a human shield, commit or facilitate the commission of a felony, inflict bodily harm or terrorize the victim or another person, or interfere with the performance of any governmental or political function. See s. 787.01(1)(a), FS.

**Liability:** occurs when a licensee fails to conduct him or herself within the standard of care for a security officer or private investigator, and that failure was the direct and proximate cause of an injury suffered.

**Manslaughter:** the killing of a human being by the act, procurement, or culpable negligence of another, without the lawful justification according to Chapter 776, Florida Statutes. See s. 782.07 (1), FS. A licensee who uses deadly force when such force is not justified under the law could be subject to criminal prosecution for manslaughter, aggravated assault, or other serious charges depending on the circumstances.

**Malfunction:** a condition that prevents a weapon from operating normally.

**Misdemeanor:** any crime for which the maximum penalty includes possible incarceration of one year or less in a county jail. See s. 775.08(2), FS.

**Negligence:** the failure of a licensee or company to use reasonable care in a situation where the failure results in harm to another.

**Negligent Entrustment:** when an agency head or supervisor, charged with the responsibility of equipping licensees with firearms, might be liable under this legal theory if he or she knew, or should have known, that a particular licensee was incompetent and, nevertheless, provided him or her with a dangerous instrument, specifically, a firearm.

**Negligent Assignment:** when an agency head or supervisor allows a licensee who's under investigation for misuse of a firearm, to remain on duty and he or she again uses deadly force in an improper manner.

**Robbery:** the taking of money or property from person or custody of another with the intent to permanently or temporarily deprive the person or owner of the money or other property, when in the course of taking there is the use of force, violence, assault, or putting in fear. See s. 812.13(1), FS.

**Shooting hand:** used to describe the hand used to shoot the firearm.

**Single-action:** mechanism performs the single action of releasing the hammer or striker.

**Squib load:** occurs when there is no powder or a partial burn of powder and the primer ignites.

**Stacked feed:** occurs when a round is in the chamber and the action is closed.

**Standard of Care:** the recognized and accepted operating procedure, principle, or practice for an occupation or profession.

**Support hand:** the hand that assists the shooting hand.

**Tactical load:** a technique used to reload in a tactical situation.

**Tort:** a civil wrong where an aggrieved party can be made whole through the awarding of damages.

**Vicarious Liability:** the attachment of liability to another person (supervisor of licensee) for the wrongful acts of a subordinate whose actions he or she orders, directs, or approves.





